

USATE LE BUONE MANIGLIE

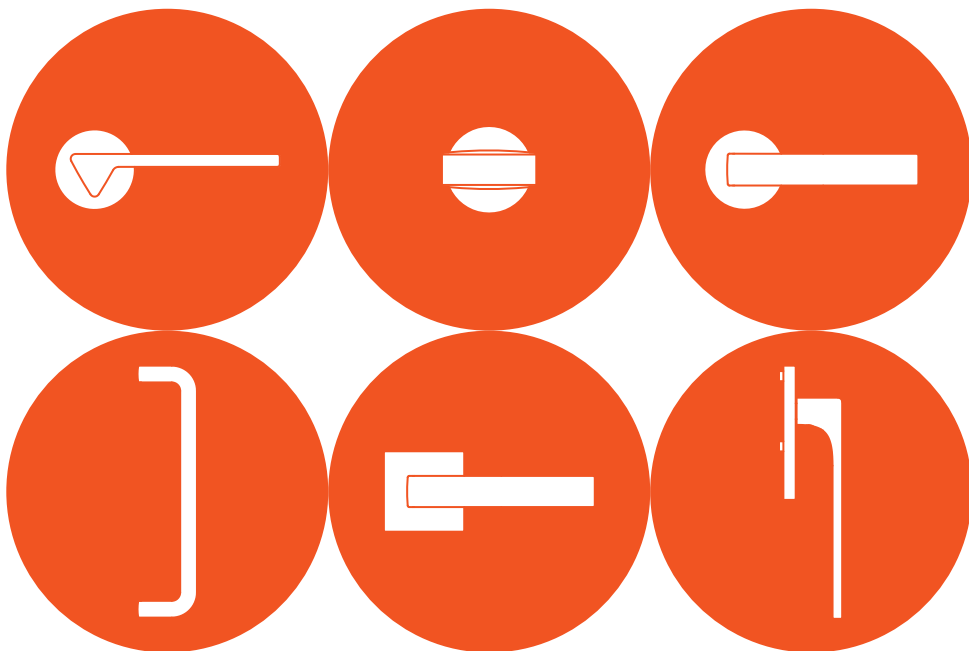

handles
collection
2 0 1 9

”

EVERYTHING IS DESIGNED.
FEW THINGS ARE DESIGNED WELL.

Colombo Design, a Family Company

“

Colombo Design: a family company.

sempre vicini a te

Proprio come una famiglia accudisce i suoi membri con amore e dedizione, così Colombo Design cura i suoi prodotti, con gli stessi valori e le medesime tradizioni, per fare di ogni ambiente una casa, senza scendere mai a compromessi sull'autenticità. Un manifesto contemporaneo dell'essere creativi, curiosi e sperimentali.

handles with care

Just like a family that handles its members with love and care, Colombo Design cares about its family of products and its production with the same values and traditions to make of any place a home, never accepting any compromise to quality and function, individuality and authenticity. Bonding heritage with creativity, curiosity and innovation.

Colombo Design: our mission.

la qualità sensibile

Intraprendere un'impresa nel terzo millennio.

Infondere entusiasmo ai collaboratori, convinti che il fattore umano sia condizione essenziale al progresso aziendale.

Produrre secondo criteri di eccellenza nelle varie fasi di lavorazione per offrire prodotti garantiti.

Rinnovare costantemente impianti e procedure per precedere i rischi dell'obsolescenza. Questi i requisiti di Colombo Design; leader mondiale nella produzione di accessori bagno, presente in 93 paesi nel mondo attraverso una fitta rete di agenti e distributori. Una realtà solida, nata nel 1991, che si estende su una superficie di 100.000 mq, di cui 25.000 mq coperti, a Terno d'Isola in provincia di Bergamo.

discerning quality

Creating a business in the third millenium.

Motivating staff by recognising that human resources are essential to the company development;

Achieving manufacturing excellence at every stage of production so that products may be guaranteed;

Continuously updating machinery and manufacturing procedures in order to maintain quality levels in harmony with our environment. These are core principles of Colombo Design, world leader in the production of handles, present in 93 countries worldwide through an extensive network of agents and distributors. A solid reality, founded in 1991, based in Terno d'Isola, in the province of Bergamo, with an area of 100,000 square meters, of which 25,000 sqm are covered.

Colombo Design network 93 countries



● Factory
BERGAMO - ITALY

● Distributors

- | | | |
|---------------------------|---------------|----------------|
| ARGENTINA | JORDAN | SWEDEN |
| ARMENIA | KAZAKHSTAN | SWITZERLAND |
| AUSTRALIA | KENYA | SYRIA |
| AUSTRIA | KYRGYZSTAN | THAILAND |
| AZERBAIJAN | KUWAIT | TUNISIA |
| BAHRAIN | LATVIA | TURKEY |
| BELARUS | LEBANON | UAE |
| BELGIUM | LIBYA | UKRAINE |
| BENIN | LITHUANIA | UNITED KINGDOM |
| BOSNIA
and HERZEGOVINA | MACEDONIA | USA |
| BRAZIL | MALAYSIA | UZBEKISTAN |
| BULGARIA | MALTA | VENEZUELA |
| CANADA | MEXICO | VIETNAM |
| CHILE | MOLDOVA | ZIMBABWE |
| CHINA | MONACO | |
| COLOMBIA | MONTENEGRO | |
| CROATIA | MOROCCO | |
| CYPRUS | NETHERLANDS | |
| CZECH REPUBLIC | NEW CALEDONIA | |
| DENMARK | NEW ZEALAND | |
| ECUADOR | NIGERIA | |
| EGYPT | OMAN | |
| ESTONIA | PAKISTAN | |
| FINLAND | PANAMA | |
| FRANCE | PHILIPPINES | |
| GEORGIA | POLAND | |
| GERMANY | PORTUGAL | |
| GREECE | PUERTO RICO | |
| HONG KONG | QATAR | |
| HUNGARY | ROMANIA | |
| ICELAND | RUSSIA | |
| INDIA | SAUDI ARABIA | |
| INDONESIA | SENEGAL | |
| IRAN | SERBIA | |
| IRAQ | SINGAPORE | |
| IRELAND | SLOVAKIA | |
| ISRAEL | SLOVENIA | |
| IVORY COAST | SOUTH AFRICA | |
| JAPAN | SOUTH KOREA | |
| | SPAIN | |



AROSE s.r.o. - showroom dverí a kľučiek
Račianska 97 - 831 02 - Bratislava - Slovakia
tel: +421 911 555 454 - e-mail: arose@arose.sk

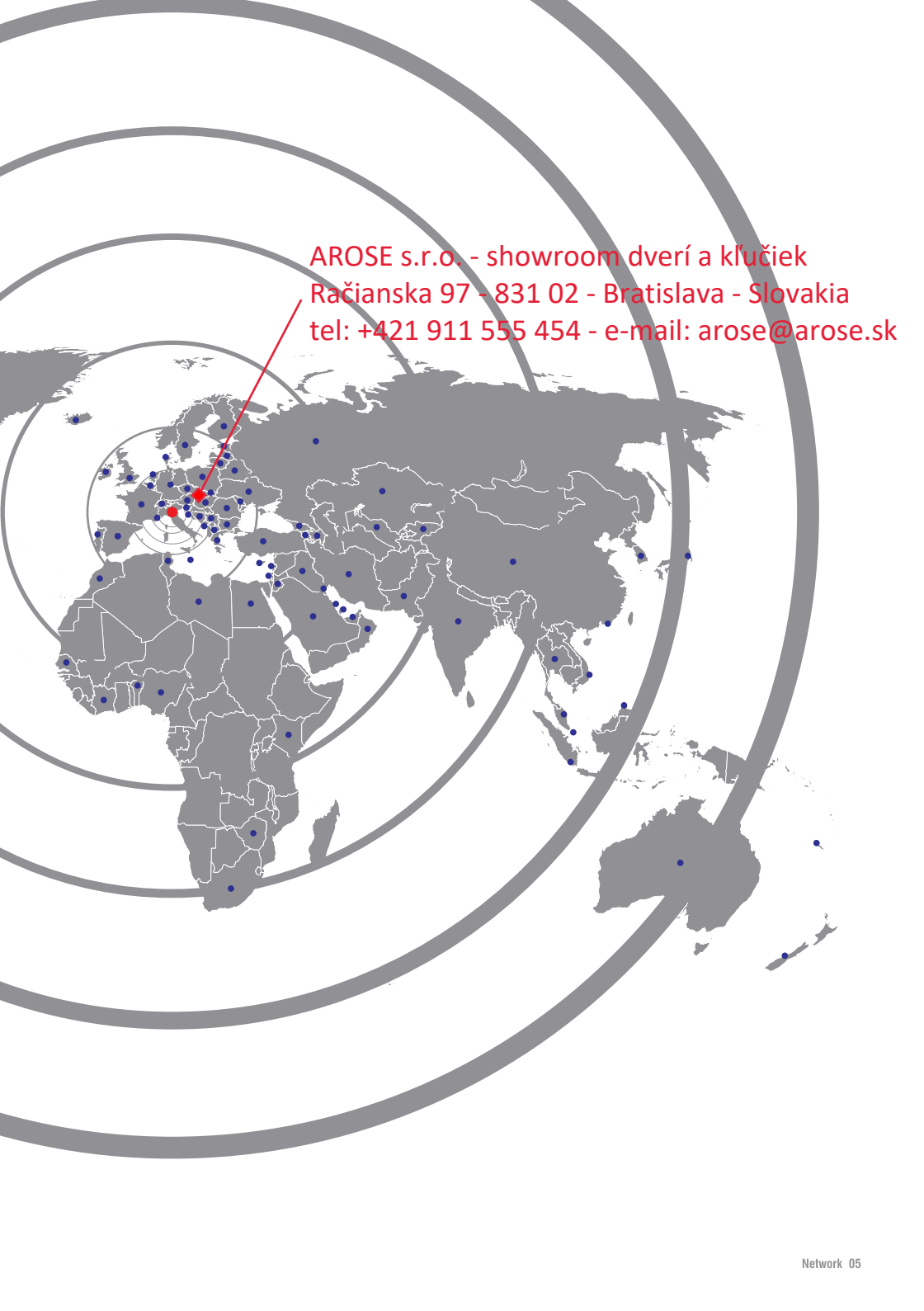

Our Designers.



ACERBIS, Marco



ANDREA MAFFEI ARCHITECTS



ANGELETTI RUZZA DESIGN



ARCHITETTURA LABORATORIO



BARTOLI DESIGN



BETTONICA, Luta
e LEONE, Giancarlo



CASTRIGNANO, Andrea



CLAESSON KOIVISTO RUNE



COLOMBO, Luca



DE LUCCHI, Michele



DI BLASI, Ottavio



GRIC, Konstantin



HASUIKE, Makio



KIMURA, Tomo



LUCCHESI, Francesco



LOHMANN, Birgit



MASSAUD, Jean Marie



MEDA, Alberto



MESSINEO e SETTIMELLI



FORM DESIGN
CATTANEO, Paolo



MORRISON, Jasper



PININFARINA, Paolo



PIO e TITO TOSO lab



PIVA, Marco



RAGNI, Matteo



RONCHI, Mauro



STUDIO KAIROS



STUDIO SPALVIERI / DEL CIOTTO

Progettare e costruire
le maniglie più belle
del mondo.

Designing and manufacturing
the most beautiful handles in
the world.

le collezioni
the collections



alba 23
ama 27
blazer 31
bold PT11 35
bold PT15 39
daytona 43
dea 47
drop 51
edo 55
electra 59
elle 63
ellesse 67
esprit 71
fedra 75
flessa 79
gaia 83
gira 87
isy 91
lara 95
libra 99
lund 103
madi 107
mapo 111
meta 115
milla LC31 119
milla LC41 123
mixa 127
moon 131
olly 135
pegaso 139
prius 143
sirio 147
slim 151
spider MR11 155
spider MR15 159
star 163
tacta 167
tailla 171
taipan 175
talita 179
tecono 183
tender 187
tool 191
trama LC71 195
trama LC81 199
twitty 203
viola 207
wing 211
zelda 215

Classic Line



cameo 221
heidi 225
ida 229
peter 233
piuma 237

ROBOTECH®



mach 243
robot CD41 247
robot CD75 251
robodue 255
robotre 259
roboquattro 263
roboquattros 267
robocinque 271
robocinques 275

pomoli
door knobs



bold PT15 280
cut 281
daytona 282
drop 283
etro 284
mapo 285
moon 286
push 287
robot 288
robot CD75 289
round 290
spider 291
square 292

maniglioni e battenti
pulls and door knockers



daytona 294
elle 295
five 296
flesso 297
logo 298
lund 299
noa 300/1
roboquattro 302
square 303
tender 304
wave 305
zen 306/7
blues 308
jazz 309
nice 310
piuma 311
robot 312
cloud 313
wind 314
am113-213y 315
id113-213y 316
id313-413y 317
id513-613y 318
lc113-213y 319
lc413-513y 320
cd113 321
cd213rs 322
flessum 323
toc-toc 323

maniglie incasso
flush handles



enter 326
open 327/8
open sq 329/30
cd111 331
cd211 331
cd311 332
cd511 332
cb111 333
id411 334
lc111 335

appenditutto
coat hangers



alidé 338
bart 339
basic 340
basic Q 341
club 342
forever 343
golf 344
hermitage 345
hook 1/2 346
khaja 347
land 348
link 349
look 350
lulu 351
melò 352
nordic 353
over 354
plus 355
polo 356
portofino 357
road 358
time 359/60
trio 361

programma blindate
armored door program



mostrine 364/5
inserti 366
pomolino 367
kit sr 368

complementi
complements



dispositivi di 370/1/2
sicurezza
dispositivi 373
antiefrazione
fermaporta 374
chiavi 375
nottolini 376/7
libero/ 378
occupato
bocchette 379
tonde
bocchette 380
quadre
rosette 381
strette
bocchette 382
strette

Our environmental approach.

Lo sviluppo è sostenibile se soddisfa i bisogni delle generazioni presenti senza compromettere le possibilità per le generazioni future di soddisfare i propri bisogni.
Sustainable development is development that meets the needs of the present without compromising the ability of future generations to meet their own needs.

(Brundtland Report, United Nations, 1987)



E' TEMPO DI GREEN MADE IT'S GREEN MADE TIME

Green Made significa pensare, progettare e produrre in armonia con l'ambiente.

Green Made: perché In una economia globale assume un ruolo sempre più importante la protezione delle risorse disponibili ed in particolare lo studio degli aspetti ambientali legati alle diverse attività produttive. L'aumento dei consumi delle risorse non rinnovabili (i minerali ed i metalli come pure i combustibili fossili), dovuto alla costante crescita della popolazione mondiale, impone standards di produzione che privilegino la conservazione delle risorse disponibili.

I nostri processi produttivi sono frutto di una globale attenzione alla tutela dell'ambiente. La gestione accurata di questi processi ha portato, tra le altre cose, all'ottenimento della certificazione UNI EN ISO 14001 «Sistema di gestione ambientale certificato».

Green Made: il valore Ogni singola fase di progettazione e produzione è attentamente analizzata sotto il profilo dell'impatto ambientale ed ogni scelta successiva dettata dal raggiungimento degli obiettivi di eco compatibilità. Così durante la produzione vera e propria, saranno le più avanzate tecnologie appositamente sviluppate ed i più severi controlli, effettuati dal personale più qualificato, a garantire Green Made by Colombo Design: un prodotto nato con il pensiero costantemente rivolto all'ambiente.

«Green made» means thinking, developing and manufacturing in harmony with our environment.

Green Made: why Protecting our resources is more and more important in a global economy, and in particular paying attention to reflections of manufacturing onto the environment. Increase of consumptions of non-renewable resources (minerals, metals and fossil combustibles) due to increase of population, imposes manufacturing standards which privilege conservation of the available resources and raw materials.

Our production processes are the result of a total attention to environmental protection. By the accurate management of these processes we obtained the UNI EN ISO 14001 certification «Certified environmental management system».

Green Made: values Each design and production step is carefully checked with regards to the environmental impact and each following decision is taken if our eco-compatibility objectives are fully reached.

This means that when we manufacture our products, the Green Made concept by Colombo Design will be assured by the advanced technologies and very strict controls carried out by a very highly qualified personnel, generating a product conceived constantly thinking of the environment.

Our Certifications.



Sistema di gestione certificato da ICIM
Certified management system by ICIM
UNI EN ISO 9001:2015

Questa certificazione è valida per il seguente campo applicativo: Progettazione e fabbricazione di maniglie, complementi per arredamento e di accessori per l'arredo del bagno in materiali non ferrosi.

This certification is valid for the following application field: Design and manufacture of handles, furniture co-ordinated accessories and bathroom furniture accessories in non ferrous materials.



Sistema di gestione certificato da ICIM
Certified management system by ICIM
UNI EN ISO 14001:2015

Questa certificazione è valida per il seguente campo applicativo: Progettazione e fabbricazione di maniglie e complementi per arredamento in materiale non ferroso, accessori per l'arredo del bagno mediante le fasi di: pressofusione, burattatura, pulitura, galvanica, verniciatura, assemblaggio, confezionamento ed immagazzinamento.

This certification is valid for the following application field: Design and manufacture of non-ferrous handles and coordinated furniture accessories, bathroom furniture accessories by: die-casting, tumble finishing, polishing, electroplating, varnishing, assembling, packing and storing.



Nuova certificazione europea per le maniglie
New European certification for door furniture
UNI EN 1906:2012

La norma Europea UNI EN 1906:2012 stabilisce requisiti e metodi di prova per maniglie e pomoli.

Colombo Design ha conseguito, per tutti i suoi modelli, lusinghieri risultati tra i quali il più significativo è il **"Grado 4"** per la categoria d'uso: sinonimo di assoluta qualità e resistenza.

The European standard UNI EN 1906:2012 establishes requirements and test methods for lever handles and knobs.

Colombo Design achieved, for all of its models, excellent results between which the most significant is the **"Grade 4"** for the category of use: synonym of absolute quality and resistance.

Colombo Design warranties



HPS SISTEMA DI ALTA PROTEZIONE HPS HIGH PROTECTION SYSTEM

TRATTAMENTO DI PROTEZIONE GARANTITO 30 ANNI Quello utilizzato da Colombo Design è un processo di finitura mutuato dal settore dell'utensileria, in cui caratteristiche fisiche e meccaniche sono studiate per garantire prestazioni eccezionali di resistenza all'usura meccanica e al decadimento dovuto ad agenti ambientali e chimici, in cui il processo è stato messo a punto per garantire anche un notevole aspetto estetico, trasparenza e lucentezza fanno risaltare il design del prodotto. Tutti i prodotti trattati con il processo PVD, vengono preventivamente rivestiti con strati di rame, nichel e cromo per garantire un perfetto isolamento della materia prima sottostante. Trattamento con la garanzia di "30 anni" sulle finiture **Zirconium Gold, Oromat, Zirconium Stainless-Steel, Vintage, Vintage Mat, Grafite e Grafite Mat**.

PRESTAZIONI RIVESTIMENTO I prodotti trattati con il processo PVD, garantiscono prestazioni di lunga durata. L'utilizzo di questi prodotti è particolarmente indicato nel caso di ambiente corrosivo, come aree marine ricche di salsedine o in zone soggette a piogge acide. L'utilizzo in pieno sole e le escursioni di temperatura non pregiudicano l'estetica del prodotto con viraggi di tonalità del colore. La durezza del rivestimento e il basso coefficiente di attrito superficiale garantiscono un'ottima resistenza ai graffi dovuti, per esempio, all'utilizzo di anelli. Eventuali ammaccature provocate da urti o colpi possono intaccare l'integrità e provocare il decadimento delle prestazioni del rivestimento.

TRATTAMENTO PVD Leggere tolleranze cromatiche, frutto del sofisticato processo PVD, nelle finiture **Vintage, Vintage Mat, Grafite e Grafite Mat** sono da considerarsi normali.

PULIZIA E MANUTENZIONE I prodotti trattati con il processo PVD, richiedono solo la normale manutenzione da effettuare per motivi estetici ed igienici. Si consiglia di utilizzare solo acqua ed eventualmente sapone neutro. Non utilizzare prodotti particolarmente aggressivi o abrasivi. Non utilizzare prodotti contenenti acido fluoridrico o muriatico.

TREATMENT PROTECTION GUARANTEED 30 YEARS Colombo Design uses a finishing process borrowed from the tools industry, where physical and mechanic features have to guarantee a very high performance as far as mechanic wear and decay due to environmental and chemical agents are concerned. This finishing process also guarantees a high level of design where transparency and brightness allow the product to reveal. All PVD-treated products with High Protection System finishing are previously coated with layers of copper, nickel and chrome in order to guarantee the perfect insulation of the underlying raw material. Treatment with warranty of "30 years" on **HPS Zirconium Gold, Matt Gold, HPS/1 Zirconium Stainless-Steel, Vintage, Vintage Mat, Graphite and Graphite Mat** finishing.

COATING PERFORMANCE All PVD-treated products with High Protection System finishing guarantee better performance than any other type of coating, either galvanic or lacquer. The use of these products is strongly recommended in such places as high-salinity marine areas or areas subject to acid rains. The use in bright sunshine and temperature ranges does not cause color changes. The hardness of the coating space and the low rate of surface friction ensure a very good resistance to scratches due to the use of rings (for example). Any dents due by hits or impact can ruin the surface and affect the coating performance.

PVD TREATMENT Due to the high sophisticated PVD process slight color tolerances for the **Vintage, Vintage Mat, Grafite** and **Grafite Mat** finishes are to be considered normal.

CLEANING AND MAINTENANCE All PVD-treated products with High Protection System finishing require the usual routine maintenance. We advise to use only neutral soap and/or water. Do not use very abrasive products. Do not use products containing hydrofluoric or muriatic acid.



GARANZIA 10 ANNI GUARANTEED 10 YEARS

TRATTAMENTO DI PROTEZIONE GARANTITO 10 ANNI La lunga esperienza maturata nel settore dei trattamenti galvanici e PVD, unita alla scelta di prestare particolare attenzione alla qualità nei processi produttivi, consentono a Colombo Design di garantire le finiture dei suoi prodotti oltre la normale copertura prevista dalla legge. E' quindi con particolare orgoglio che offriamo ai nostri utenti la garanzia di "10 anni" sulle finiture **Oroplus, Cromo e Cromat**.

Questo impegno di durata nel tempo del prodotto è la nostra forte ed alternativa risposta al consumismo «usa e getta», sinonimo di spreco ambientale e nemico della memoria collettiva, irrinunciabile valore di tutte le società.

Per un utilizzo ottimale del prodotto, ed ottemperare alle regole della garanzia:

- . evitare l'impiego di sostanze solventi, abrasivi, alcool
- . rimuovere le eventuali tracce di sporco e polvere solo con un panno inumidito in acqua tiepida.

TREATMENT PROTECTION GUARANTEED 10 YEARS The long experience in the field of galvanic treatments, combined with the choice to pay special attention to the quality in production processes, enable Colombo Design to ensure the finishes of its products beyond the normal warranty provided by law. It is therefore with great pleasure, we offer to our end-users the warranty of "10 years" on **Oroplus, Chrome** and **Matt chrome** finishing. This commitment of product durability is our strong and alternative response to consumerism «disposable», synonymous with environmental waste and enemy of collective memory, an essential value of all societies. For maximum performance, kindly comply with the rules of warranty:

- . do not use solvents, abrasives or alcohol
- . remove any traces of dirt and dust with only just a cloth dampened in water.

Colombo Design innovations & finishes



SIX MILLIMETERS CONCEPT

Maniglie con rosetta e bocchetta bassa che non necessitano di lavorazioni aggiuntive sulla porta.
Handles with slim rose and escutcheon. They don't need additional installation works on the door.

Modelli disponibili
Available models

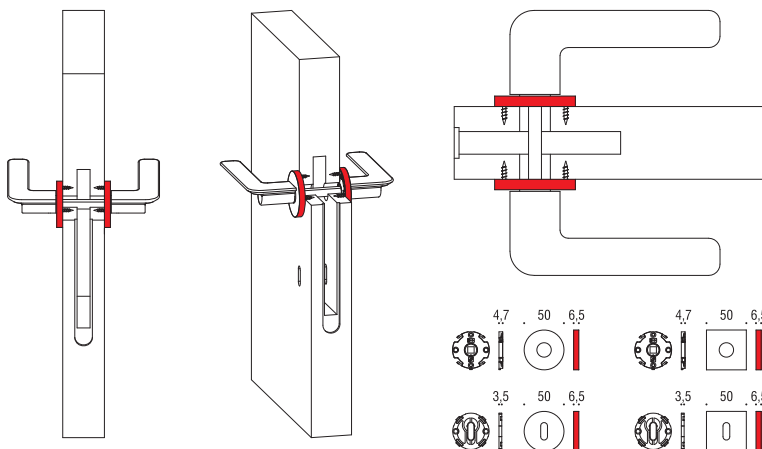

ROBOTECH®

Robotech® contraddistingue una gamma di prodotti realizzata utilizzando alta tecnologia e massima automazione per ottenere eccellenza qualitativa e commerciale.

Robotech® is our mark for those products manufactured using high technologies and ultimate automation, to create quality and trading excellence.



CASA SICURA SAFE HOUSE

La soluzione per vivere in una casa sicura. Se vuoi avere la sicurezza di vivere in un ambiente tranquillo e sereno, affidati al sistema antintrusione di Colombo Design! Il pulsante blocca maniglia ne impedisce la rotazione, di conseguenza i malintenzionati non riusciranno più ad entrare nelle vostre case passando dalle finestre e dalle porte finestre.

The right solution for a safe house. If you're looking for a safe feeling while being in your home, you should use the Colombo Design Security System! The button locks the handle preventing the rotation, so bad people won't be able to enter your house, not via the doors non the windows.

PROCESSO PRODUTTIVO PRODUCTION PROCESS

-  OTTONE . CROMALL® leghe metalliche con qualità certificata
BRASS . CROMALL® metal alloys of certified quality
-  strato di pre-rame elettrodeposto
first electroplated copper layer
-  secondo strato di rame elettrodeposto
second electroplated copper layer
-  strato livellante di NICHEL elettrodeposto ad altissimo spessore
very high electroplated NICKEL levelling layer
-  strato elettrodeposto | **OROPLUS, CROMO,**
electroplated | **CROMAT**
-  trattamento PVD solo per finiture | **HPS ZIRCONIUM GOLD, HPS STAINLESS-STEEL,**
PVD treatment applicable only on finishings | **OROMAT, VINTAGE, VINTAGE MAT, GRAFITE, GRAFITE MAT**

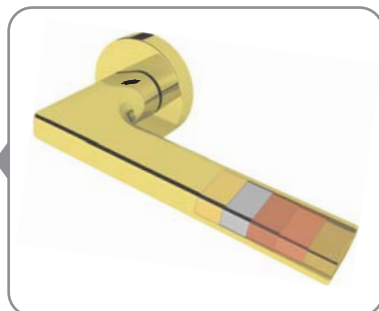

 stampaggio marchio di originalità
trademark printing



Zirconium
gold HPS



Oroplus



Oromat
Matt gold



Zirconium
stainless-steel HPS



Cromo
Chrome



Cromat
Matt chrome



Nikelmat
Matt nickel



Vintage



Vintage Mat



Grafite
Graphite



Grafite Mat
Matt Graphite



Bronzo
Bronze



Bronzo antico
Antique bronze



Ottone antico
Antique brass



Neromat
Matt Black
RAL 9005



Biancomat
Matt White
RAL 9016

graphite & graphite mat

alba / elle / ellesse / lund



vintage colours

il passato prossimo.
reliving the past now.

Collezione di prodotti realizzati nella nuova finitura Vintage, versione lucida e satinata, che unisce passato e futuro.

Products realized in the new Vintage finish, available polished or satin, that unify past and future.

electra / fedra / gira / robo4s / viola



predaj a technická podpora: AROSE s.r.o. / RAČIANSKA 97 / BRATISLAVA / 831 02 / TEL: +421 911 555 454 / E-MAIL: arose@arose.sk

LE COLLEZIONI

THE COLLECTIONS

predaj a technická podpora: AROSE s.r.o. / RAČIANSKA 97 / BRATISLAVA / 831 02 / TEL: +421 911 555 454 / E-MAIL: arose@arose.sk

ALBA

Design: Luca Colombo



LC 91



alba

Design: Luca Colombo

Materiale: Ottone/Cromall®
Material: Brass/Cromall®



**six millimeters
concept**
maniglie con rosetta e bocchetta
bassa che non necessitano di
lavorazioni aggiuntive sulla porta,
handles with slim rose and
escutcheon don't need additional
installation works on the door.



CR/CM
Cromo/Cromat
Chrome/Matt chrome



GL/GM
Grafite/Grafite Mat
Graphite/Matt graphite

LC 91 R-RY

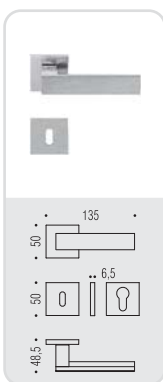

FF 29 BZG 6/8

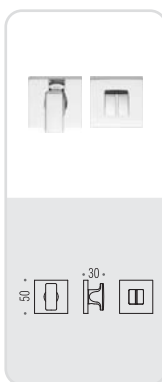

LC 92 IM

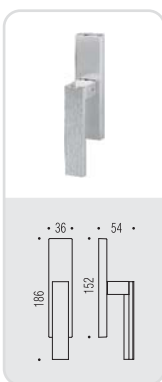

LC 92 DK/SM

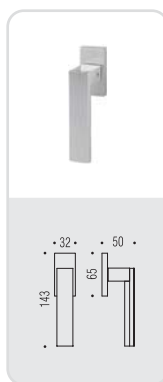



AMA

Andrea Maffei Architects





ama

Design: Andrea Maffei Architects

Materiale: Ottone/Cromall®
Material: Brass/Cromall®



six millimeters
concept

maniglie con rosetta e bocchetta
bassa che non necessitano di
lavorazioni aggiuntive sulla porta,
handles with slim rose and
escutcheon don't need additional
installation works on the door.



CR
Cromo
Chrome



CM
Cromat
Matt chrome



GL
Grafito
Graphite



GM
Grafito Mat
Matt graphite

MF 11 R-RY

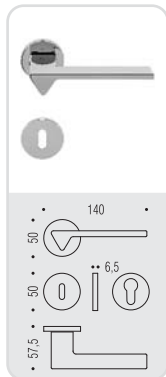

MF 19 BZG 6/8



MF 12 IM

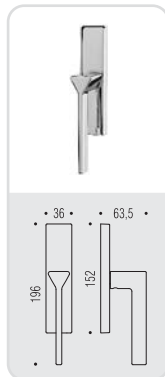

MF 12 DK/SM

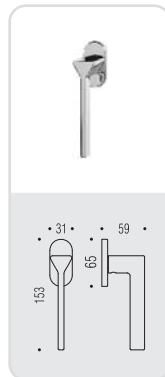



BLAZER

Design: Francesco Lucchese





blazer

Design: Francesco Lucchese

Materiale: Ottone
Material: Brass



HPS
Zirconium gold HPS



OL
Oroplus



HPS/1
Zirconium stainless-steel HPS



CM
Cromat
Matt chrome

FL 11 R-RY

HPS OL HPS1 CM

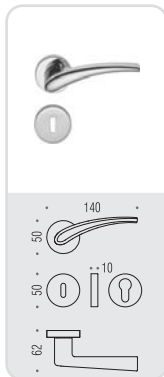

CD 49 BZG G 6/8

HPS OL HPS1 CM



FL 12 IM

HPS OL HPS1 CM

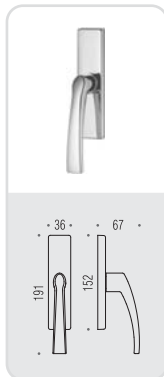

FL 12 DK/SM

HPS OL HPS1 CM

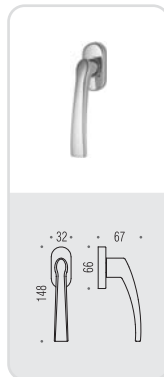



BOLD

Design: Pio e Tito Toso lab



PT 11



bold

Design: Pio e Tito Toso lab

Materiale: Ottone
Material: Brass



CR
Cromo
Chrome



CM
Cromat
Matt chrome

PT 11 R-RY

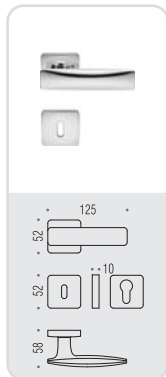

PT 19 BZG 6/8

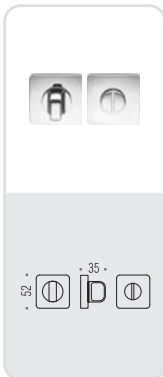

PT 12 IM

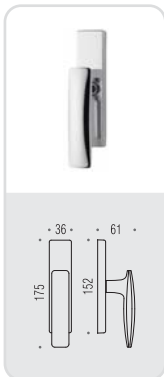

PT 12 DK/SM

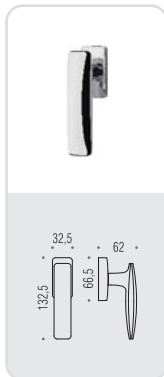



BOLD

Design: Pio e Tito Toso lab



PT 15



bold

Design: Pio e Tito Toso lab

Materiale: Ottone
Material: Brass



CR
Cromo
Chrome



CM
Cromat
Matt chrome

PT 15 R-RY

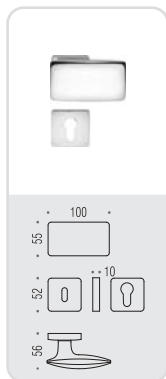

PT 19 BZG 6/8





DAYTONA

Design: *pininfarina*





daytona

Design: *piarinferina*

Materiale: Ottone
Material: Brass



OL
Oropus



CM
Cromat
Matt chrome

PF 11 R-RY

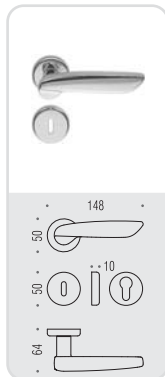

CD 69 BZG G 6/8

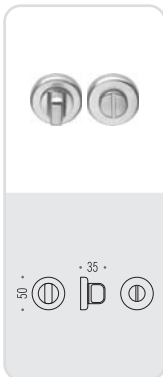

PF 12 IM

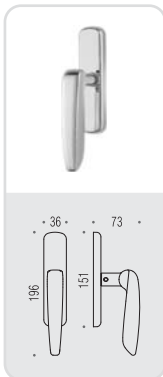

PF 12 DK/SM

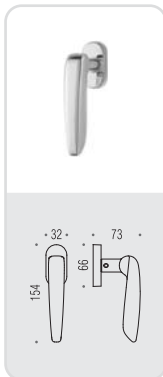



DEA

Design: Pio e Tito Toso lab



FF 21



dea

Design: Pio e Tito Toso lab

Materiale: Ottone
Material: Brass



six millimeters concept

maniglie con rosetta e bocchetta
bassa che non necessitano di
lavorazioni aggiuntive sulla porta,
handles with slim rose and
escutcheon don't need additional
installation works on the door.



CR
Cromo
Chrome



CM
Cromat
Matt chrome

FF 21 R-RY

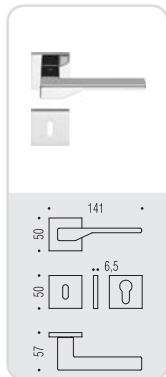

FF 29 BZG 6/8

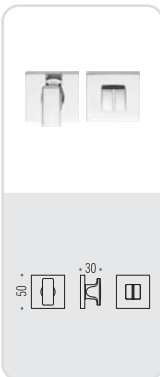

FF 22 IM

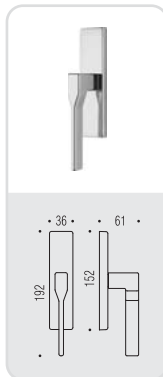

FF 22 DK/SM

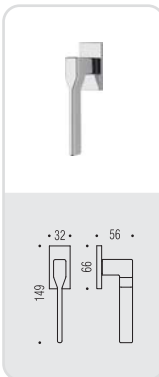



DROP

Design: Luca Colombo





drop

Design: Luca Colombo

Materiale: Ottone
Material: Brass



HPS
Zirconium gold HPS



CR
Cromo
Chrome



CM
Cromat
Matt chrome



BR
Bronzo
Bronze

LC 45 R-RY

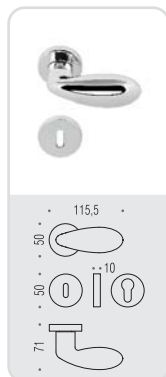

CD 49 BZG G 6/8





EDO

Design: Makio Hasuike





edo

Design: Makio Hasuike

Materiale: Ottone
Material: Brass



OL
Oroplus



CM
Cromat
Matt chrome

MH 11 R-RY

OL CM

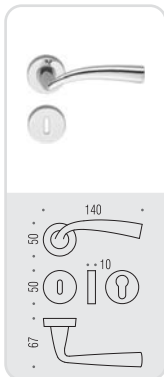

CD 49 BZG G 6/8

OL CM



MH 12 IM

OL CM

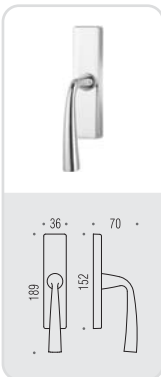

MH 12 DK/SM

OL CM

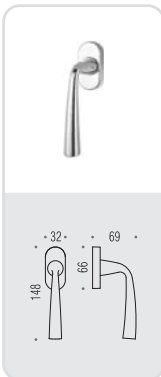



ELECTRA

Design: Messineo e Settimelli



MS 11



electra

Design: Messineo e Settimelli

Materiale: Cromall®
Material: Cromall®



six millimeters
concept

maniglie con rosetta e bocchetta
bassa che non necessitano di
lavorazioni aggiuntive sulla porta,
handles with slim rose and
escutcheon don't need additional
installation works on the door.



CR
Cromo
Chrome



CM
Cromat
Matt chrome



VL
Vintage

vintage



VM
Vintage Mat

vintage



NM
Neromat
Matt black

MS 11 R-RY

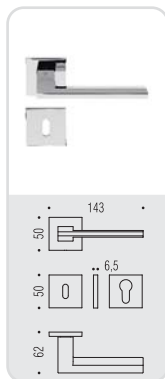

FF 29 BZG 6/8

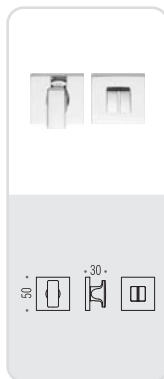

MS 12 IM

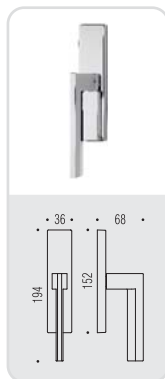

MS 12 DK/SM

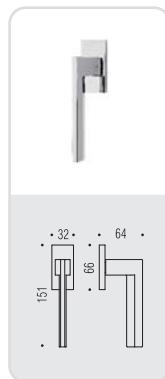



ELLE

Design: Bartoli Design





elle

Design: Bartoli Design

Materiale: Cromall®/Ottone
Material: Cromall®/Brass



CR
Cromo
Chrome



GL
Grafite
Graphite



CM
Cromat
Matt chrome



GM
Grafite Mat
Matt graphite

VERSIONE STANDARD
STANDARD VERSION

BD 11 R-RY

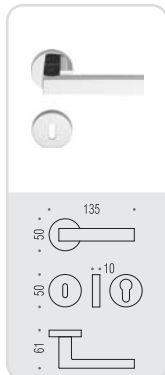

CD 49 BZG G 6/8



BD 12 IM

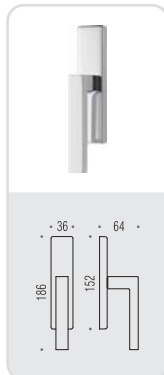

BD 12 DK/SM

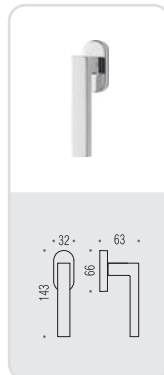

VARIANTI DISPONIBILI
ALSO AVAILABLE

BD 11 RF-RYF

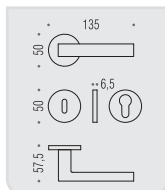

FF 19 BZG 6/8

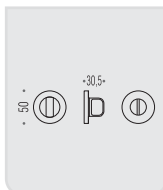

BD 12 DKF/SM

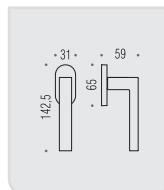

**six millimeters
concept**
maniglie con rosetta e bocchetta
bassa che non necessitano di
lavorazioni aggiuntive sulla porta.
handles with slim rose and
escutcheon don't need additional
installation works on the door.



ELLESSE

Design: Bartoli Design



BD 21



ellesse

Design: Bartoli Design

Materiale: Cromall®/Ottone
Material: Cromall®/Brass



CR
Cromo
Chrome



GL
Grafite
Graphite



CM
Cromat
Matt chrome



GM
Grafite Mat
Matt graphite

VERSIONE STANDARD
STANDARD VERSION

BD 21 R-RY

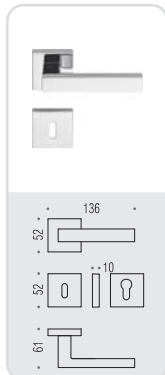

MM 29 BZG 6/8

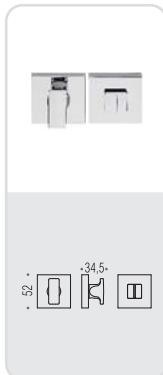

BD 12 IM

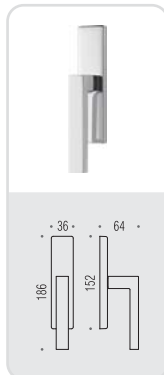

BD 22 DK/SM

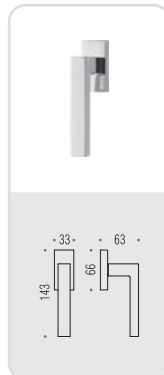

VARIANTI DISPONIBILI
ALSO AVAILABLE

BD 21 RF-RYF

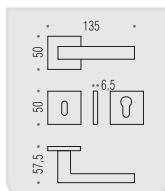

FF 29 BZG 6/8

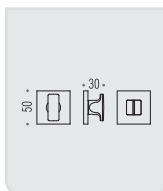

BD 22 DKF/SM

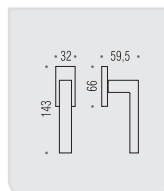

**six millimeters
concept**
maniglie con rosetta e bocchetta
bassa che non necessitano di
lavorazioni aggiuntive sulla porta.
handles with slim rose and
escutcheon don't need additional
installation works on the door.



ESPRIT

Design: Birgit Lohmann



BT 21

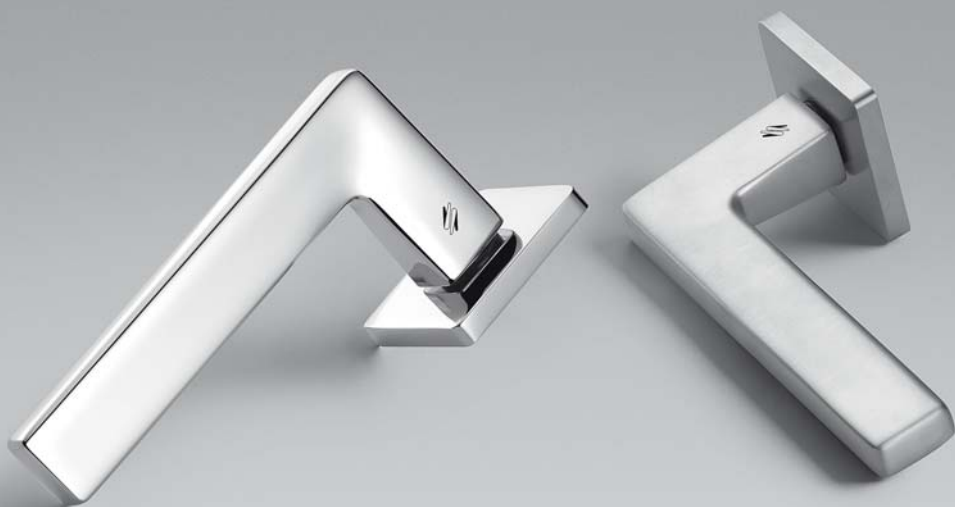

esprit

Design: Birgit Lohmann

Materiale: Ottone
Material: Brass



six millimeters
concept

maniglie con rosetta e bocchetta
bassa che non necessitano di
lavorazioni aggiuntive sulla porta,
handles with slim rose and
escutcheon don't need additional
installation works on the door.



HPS/1
Zirconium stainless-steel HPS



CR
Cromo
Chrome



CM
Cromat
Matt chrome

BT 11 R-RY

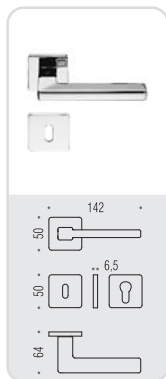

BT 19 BZG 6/8

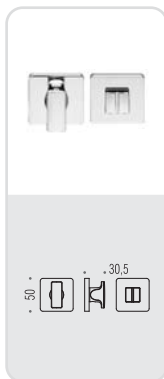

BT 12 IM

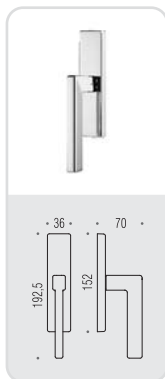

BT 12 DK/SM

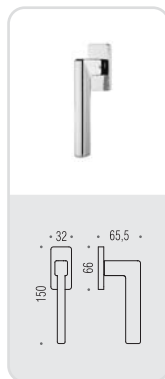



FEDRA

Design: Andrea Castrignano



AC 11



fedra

Design: Andrea Castrignano

Materiale: Ottone
Material: Brass



six millimeters
concept

maniglie con rosetta e bocchetta
bassa che non necessitano di
lavorazioni aggiuntive sulla porta,
handles with slim rose and
escutcheon don't need additional
installation works on the door.



OL
Oroplus



CR
Cromo
Chrome



CM
Cromat
Matt chrome



VL
Vintage

vintage



VM
Vintage Mat

vintage

AC 11 R-RY

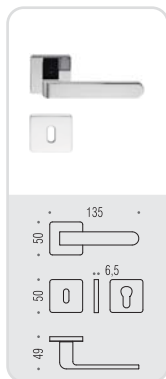

BT 19 BZG 6/8

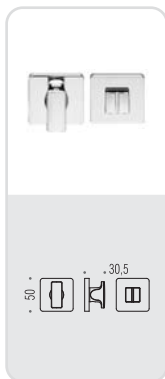

AC 12 IM

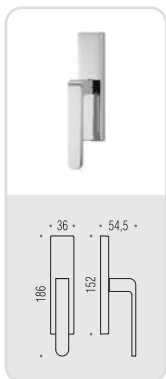

AC 12 DK/SM

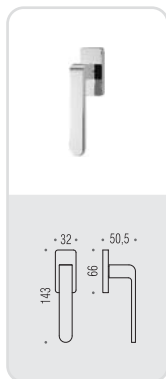



FLESSA

Design: Carlo Bartoli





flessa

Design: Carlo Bartoli

Materiale: Ottone
Material: Brass



HPS
Zirconium gold HPS



OL
Oroplus



CM
Cromat
Matt chrome



NI
Nikelmat
Matt nickel

CB 51 R-RY

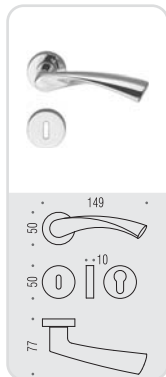

CD 49 BZG G 6/8



CB 52 M

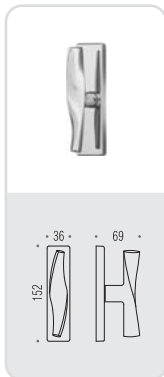

CB 52 DK/SM DX-SX

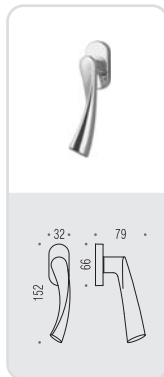



GAIA

Design: Giulio Ripamonti





gaia

Design: Giulio Ripamonti

Materiale: Ottone
Material: Brass



OL
Oroplus



CR
Cromo
Chrome



CM
Cromat
Matt chrome

GR 11 R-RY

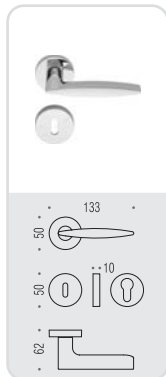

CD 49 BZG G 6/8



GR 12 IM

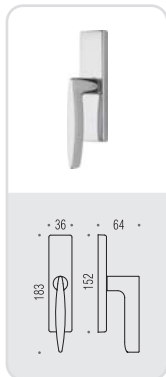

GR 12 DK/SM

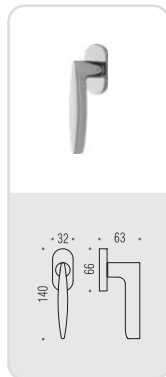



GIRA

Design: Jasper Morrison





gira

Design: Jasper Morrison

Materiale: Ottone
Material: Brass



OL
Oroplus



CR
Cromo
Chrome



HPS/1
Zirconium stainless-steel HPS



CM
Cromat
Matt chrome



VL
Vintage

vintage



VM
Vintage Mat

vintage

JM 11 R-RY

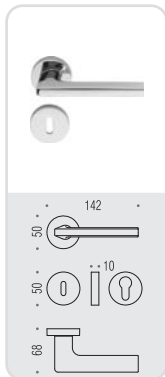

CD 49 BZG G 6/8



JM 12 IM

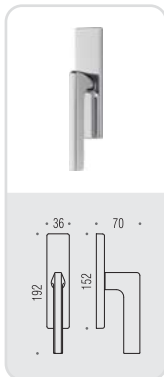

JM 12 DK/SM

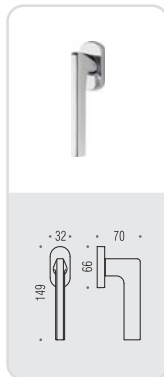



ISY

Design: Luta Bettonica
e Giancarlo Leone



BL 11



isy

Design: Luta Bettonica e Giancarlo Leone

Materiale: Ottone
Material: Brass



CR
Cromo
Chrome



CM
Cromat
Matt chrome

VERSIONE STANDARD
STANDARD VERSION

BL 11 R-RY

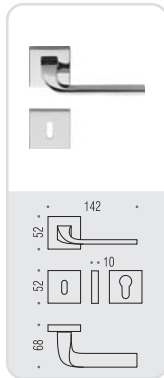

MM 29 BZG 6/8

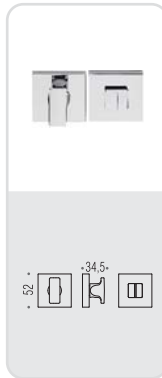

BL 12 IM

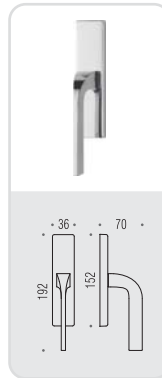

BL 12 DK/SM

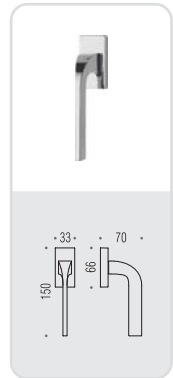

VARIANTI DISPONIBILI
ALSO AVAILABLE

BL 11 RF-RYF

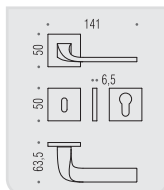

FF 29 BZG 6/8

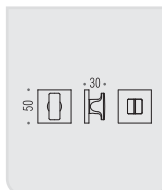

BL 12 DKF/SM

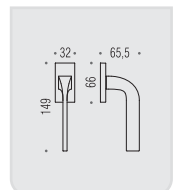

**six millimeters
concept**

maniglie con rosetta e bocchetta
bassa che non necessitano di
lavorazioni aggiuntive sulla porta.
handles with slim rose and
escutcheon don't need additional
installation works on the door.



LARA

Design: Carlo Bartoli





lara

Design: Carlo Bartoli

Materiale: Ottone
Material: Brass



HPS
Zirconium gold HPS



OL
Oroplus



OM
Oromat
Matt gold



CM
Cromat
Matt chrome



NI
Nikelmat
Matt nickel

CB 71 R-RY

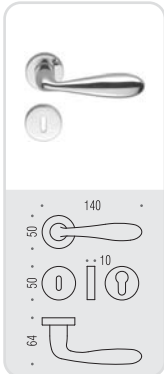

CD 49 BZG G 6/8



CB 72 IM

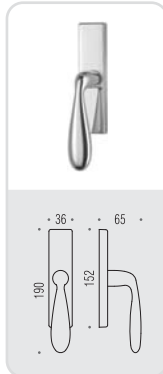

CB 72 DK/SM

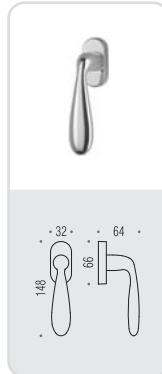



LIBRA

Design: Studio Kairos





libra

Design: Studio Kairos

Materiale: Ottone
Material: Brass



OL
Oropius



CR
Cromo
Chrome

SK 21 R-RY

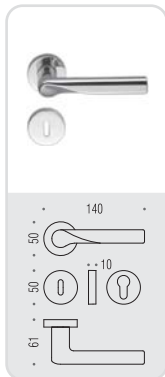

CD 49 BZG G 6/8



SK 22 M

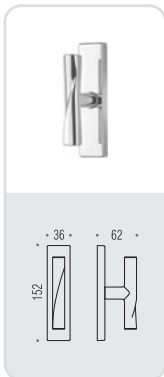

SK 22 DK/SM

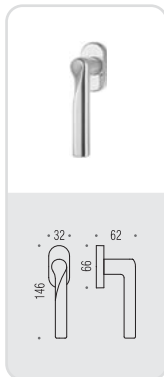



LUND

Design: Claesson Koivisto Rune





lund

Design: Claesson Koivisto Rune

Materiale: Ottone
Material: Brass



six millimeters
concept

maniglie con rosetta e bocchetta
bassa che non necessitano di
lavorazioni aggiuntive sulla porta.
handles with slim rose and
escutcheon don't need additional
installation works on the door.



CR
Cromo
Chrome



CM
Cromat
Matt chrome



GL
Grafito
Graphite



GM
Grafito Mat
Matt graphite

SE 11 R-RY

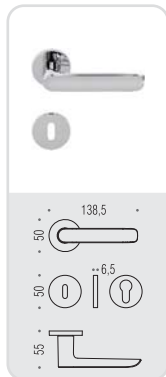

SE 19 BZG 6/8



SE 12 IM

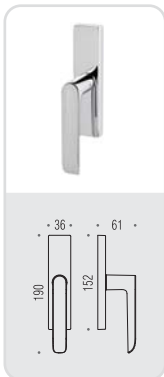

SE 12 DK/SM

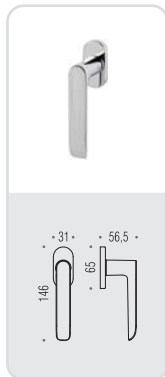



MADI

Design: Alberto Meda





madi

Design: Alberto Meda

Materiale: Ottone
Material: Brass



**Selezione d'onore
Compasso d'Oro
ADI 1998**



OL
Oropius



OM
Oromat
Matt gold



CM
Cromat
Matt chrome

AM 31 R-RY

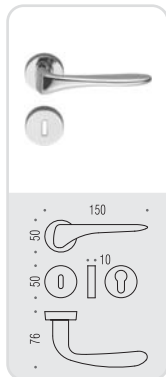

CD 49 BZG G 6/8



AM 32 M

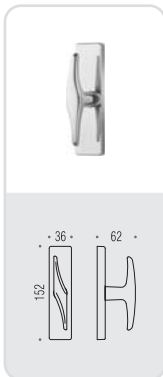

AM 32 DK/SM DX-SX

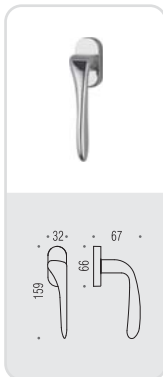



MAPO

Design: Mauro Ronchi





mapo

Design: Mauro Ronchi

Materiale: Ottone
Material: Brass



CR
Cromo
Chrome



CM
Cromat
Matt chrome

RM 15 R-RY

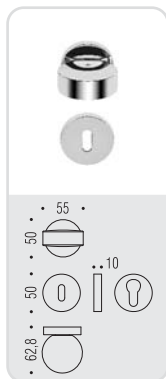

CD 49 BZG G 6/8





META

Design: Konstantin Grcic





meta

Design: Konstantin Grcic

Materiale: Ottone
Material: Brass



CR
Cromo
Chrome



CM
Cromat
Matt chrome

KG 11 R-RY

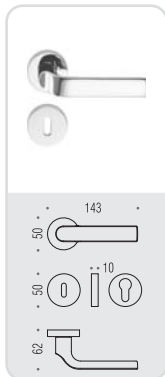

CD 49 BZG G 6/8



KG 12 IM

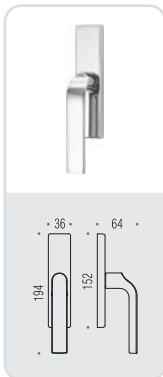

KG 12 DK/SM

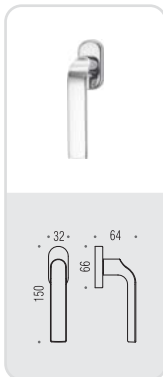



MILLA

Design: Luca Colombo





milla

Design: Luca Colombo

Materiale: Cromall®
Material: Cromall®



OL/OM
Oroplus/Oromat
Oroplus/Matt gold



CR/CM
Cromo/Cromat
Chrome/Matt chrome

LC 31 R-RY

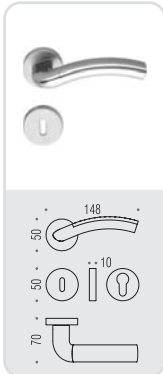

CD 49 BZG G 6/8



LC 32 IM

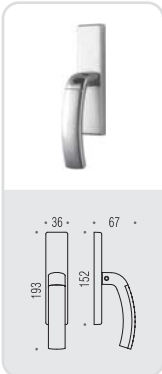

LC 32 DK/SM

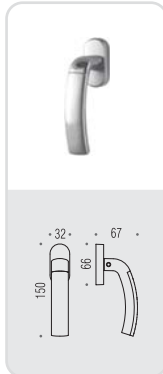



MILLA

Design: Luca Colombo





milla

Design: Luca Colombo

Materiale: Cromall®
Material: Cromall®



OL/OM
Oroplus/Cromat
Oroplus/Matt gold



CR/CM
Cromo/Cromat
Chrome/Matt chrome

LC 41 R-RY

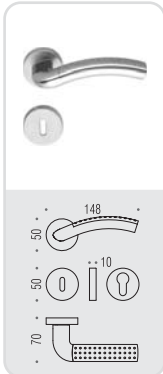

CD 49 BZG G 6/8



LC 42 IM

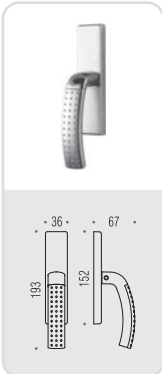

LC 42 DK/SM

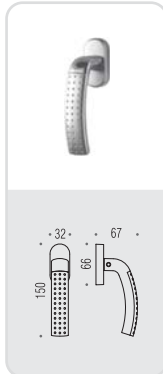



MIXA

Design: Carlo Bartoli





mixa

Design: Carlo Bartoli

Materiale: Ottone
Material: Brass



OL/OM
Oroplus/Oromat
Oroplus/Matt gold



CR/CM
Cromo/Cromat
Chrome/Matt chrome

CB 21 R-RY

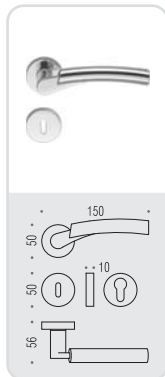

CD 49 BZG G 6/8



CB 22 M

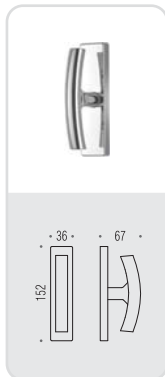

CB 22 DK/SM DX-SX

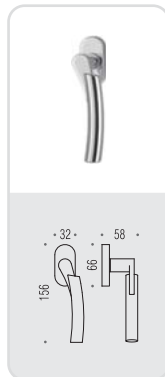



MOON

Design: Bartoli Design





moon

Design: Bartoli Design

Materiale: Ottone
Material: Brass



HPS
Zirconium gold HPS



CR
Cromo
Chrome



CM
Cromat
Matt chrome

BD 15 R-RY

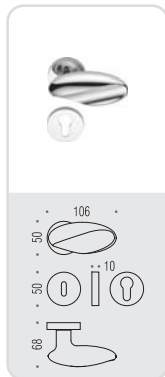

CD 49 BZG G 6/8





OLLY

Design: Luca Colombo





olly

Design: Luca Colombo

Materiale: Ottone
Material: Brass



OL
Oroplus



CR
Cromo
Chrome



CM
Cromat
Matt chrome

LC 61 R-RY

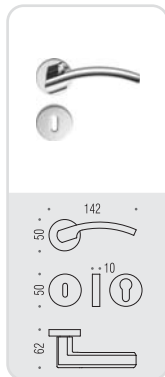

CD 49 BZG G 6/8



LC 62 IM

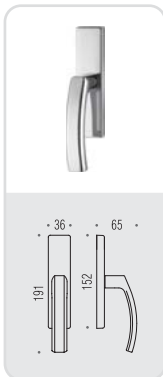

LC 62 DK/SM

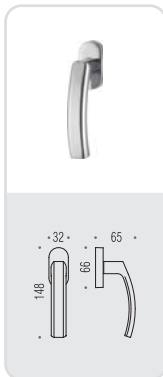



PEGASO

Design: Alberto Meda





pegaso

Design: Alberto Meda

Materiale: Ottone
Material: Brass



CR
Cromo
Chrome



CM
Cromat
Matt chrome

AM 11 R-RY

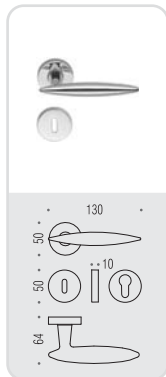

CD 49 BZG G 6/8



AM 12 M

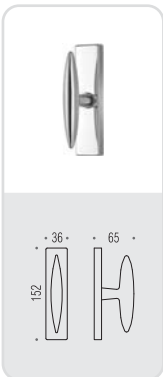

AM 12 DK/SM

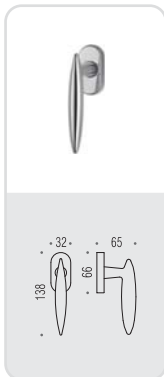



PRIUS

Design: Marco Acerbis



MA 11



prius

Design: Marco Acerbis

Materiale: Ottone
Material: Brass



Selezione d'onore
Compasso d'Oro
ADI 2008



CR
Cromo
Chrome



CM
Cromat
Matt chrome

MA 11 R-RY

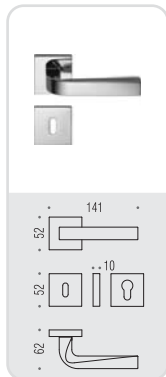

MM 29 BZG 6/8

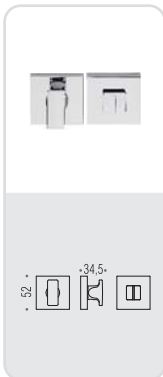

MA 12 IM

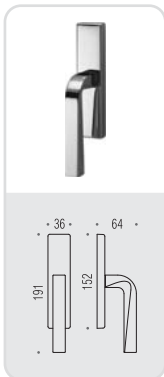

MA 12 DK/SM

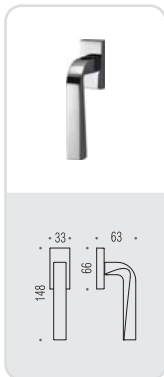



SIRIO

Design: Colombo Design





sirio

Design: Colombo Design

Materiale: Ottone
Material: Brass



OL
Oropius



CR
Cromo
Chrome



CM
Cromat
Matt chrome

CD 11 R-RY

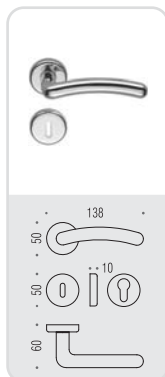

CD 69 BZG G 6/8

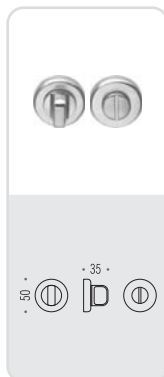

CD 12 M



CD 12 DK/SM DX-SX





SLIM

Design: Studio Spalvieri / Del Ciotto





slim

Design: Studio Spalvieri / Del Ciotto

Materiale: Ottone
Material: Brass



**six millimeters
concept**

maniglie con rosetta e bocchetta
bassa che non necessitano di
lavorazioni aggiuntive sulla porta,
handles with slim rose and
escutcheon don't need additional
installation works on the door.



CR
Cromo
Chrome



CM
Cromat
Matt chrome

FF 11 R-RY

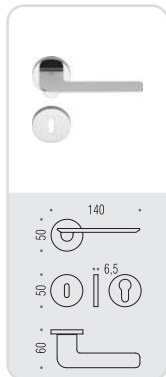

FF 19 BZG 6/8

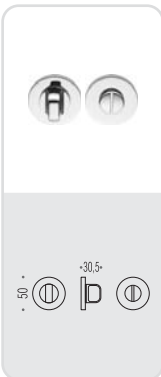

FF 12 IM

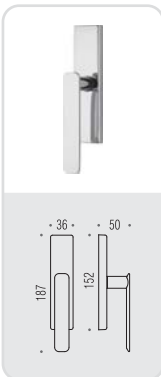

FF 12 DK/SM

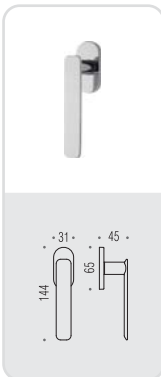



SPIDER

Design: Matteo Ragni





spider

Design: Matteo Ragni

Materiale: Ottone
Material: Brass



CR
Cromo
Chrome



CM
Cromat
Matt chrome

MR 11 R-RY

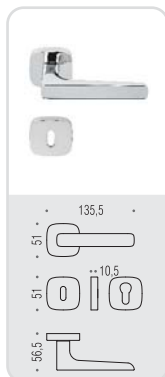

MR 29 BZG G 6/8



MR 12 IM

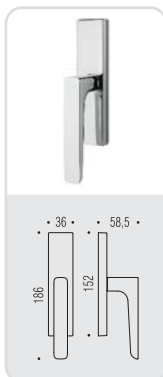

MR 12 DK/SM

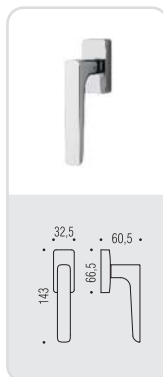



SPIDER

Design: Matteo Ragni





spider

Design: Matteo Ragni

Materiale: Ottone
Material: Brass



CR
Cromo
Chrome



CM
Cromat
Matt chrome

MR 15 R-RY



MR 29 BZG G 6/8





STAR

Design: Colombo Design





star

Design: Colombo Design

Materiale: Ottone
Material: Brass



CM
Cromat
Matt chrome



NM
Neromat
Matt black

CD 01 R-RY

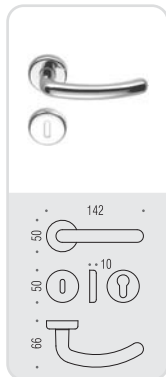

CD 69 BZG G 6/8

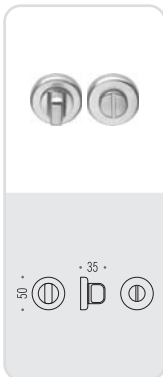

CD 02 IM

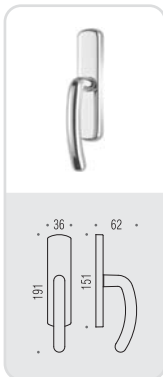

CD 02 DK/SM

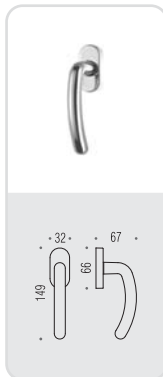



TACTA

Design: Carlo Bartoli





tacta

Design: Carlo Bartoli

Materiale: Ottone e legno massello
Material: Brass and genuine wood

Le differenze di venatura e colore che si riscontrano sul particolare in legno, sono dovute esclusivamente all'utilizzo di masselli
Grain and colour differences you notice on the piece are natural characteristics of the genuine wood



NI/EM
Nikelmat/Ebano makassar
Matt nickel/Makassar ebony



NI/PE
Nikelmat/Pero
Matt nickel/Pear wood

CB 11 R-RY

CD 39 BZG 6/8

CB 12 IM

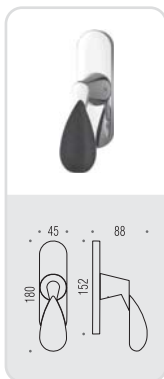
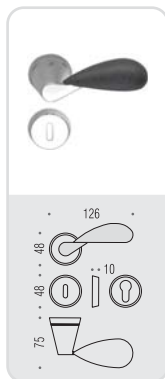



TAILLA

Design: Luca Colombo





tailla

Design: Luca Colombo

Materiale: Cromall®
Material: Cromall®



OL/OM
Oroplus/Oromat
Oroplus/Matt gold



CR/CM
Cromo/Cromat
Chrome/Matt chrome

LC 51 R-RY

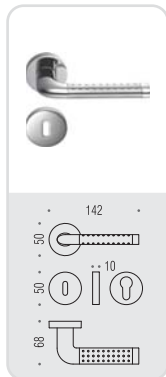

CD 49 BZG G 6/8



LC 52 IM

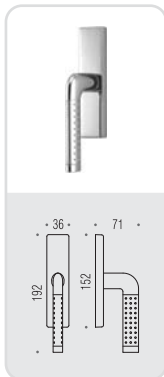

LC 52 DK/SM

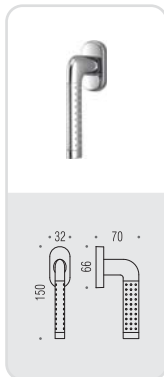



TAIPAN

Design: Luca Colombo





taipan

Design: Luca Colombo

Materiale: Cromall®

Material: Cromall®



OL/OM
Oroplus/Oromat
Oroplus/Matt gold



CR/CM
Cromo/Cromat
Chrome/Matt chrome

LC 11 R-RY

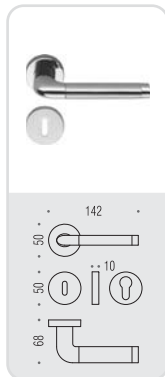

CD 49 BZG G 6/8



LC 12 IM

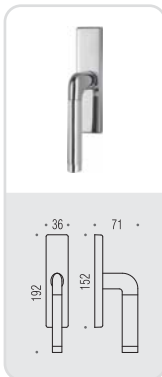

LC 12 DK/SM

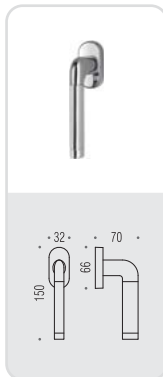



TALITA

Design: Luca Colombo





talita

Design: Luca Colombo

Materiale: Cromall®
Material: Cromall®



OL/OM
Oroplus/Oromat
Oroplus/Matt gold



CM/CR
Cromat/Cromo
Matt chrome/Chrome

LC 21 R-RY

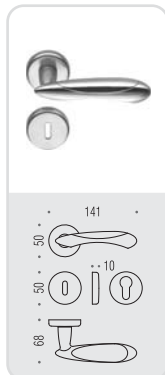

CD 69 BZG G 6/8

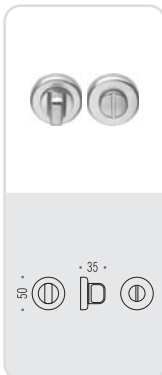

LC 22 IM

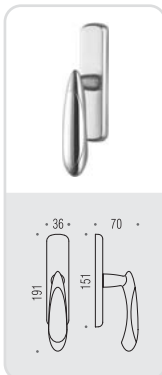

LC 22 DK/SM

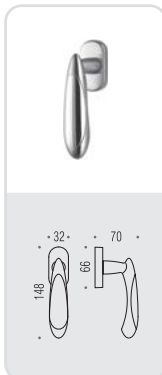



TECNO

Design:  DESIGN



MO 11



tecno

Design: **MEMO**DESIGN

Materiale: Cromall®
Material: Cromall®



**six millimeters
concept**

maniglie con rosetta e bocchetta
bassa che non necessitano di
lavorazioni aggiuntive sulla porta,
handles with slim rose and
escutcheon don't need additional
installation works on the door.



CM/CMQ
Cromat/Carbonium
Matt chrome/Carbonium



CM/CR
Cromat/Cromo
Matt chrome/Chrome

MO 11 R-RY

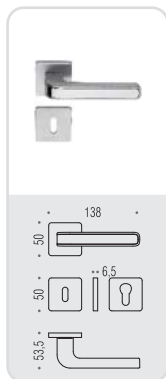

BT 19 BZG 6/8

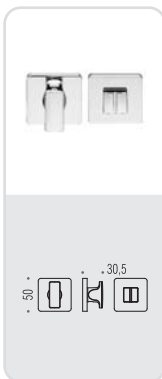

MO 12 IM

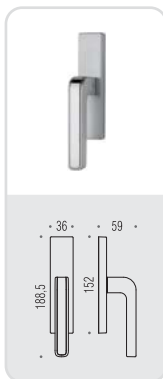

MO 12 DK/SM

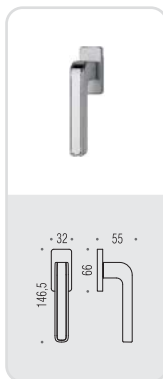



TENDER

Design: Architettura Laboratorio





tender

Design: Architettura Laboratorio

Materiale: Ottone
Material: Brass



OL
Oropus



CM
Cromat
Matt chrome



NI
Nikelmat
Matt nickel

MG 11 R-RY

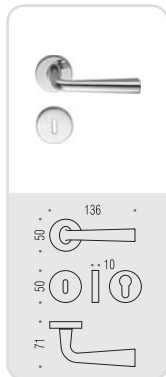

CD 49 BZG G 6/8



MG 12 IM

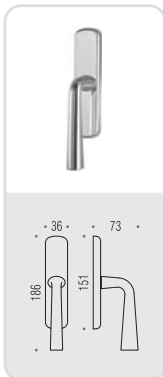

MG 12 DK/SM

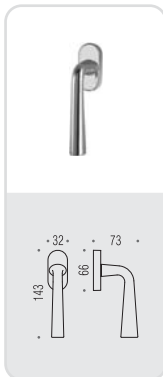



TOOL

Design: Michele De Lucchi





tool

Design: Michele De Lucchi

Materiale: Ottone
Material: Brass



CR
Cromo
Chrome



CM
Cromat
Matt chrome

VERSIONE STANDARD
STANDARD VERSION

MD 11 R-RY

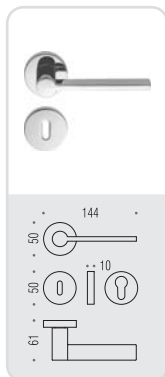

CD 49 BZG G 6/8



MD 12 IM

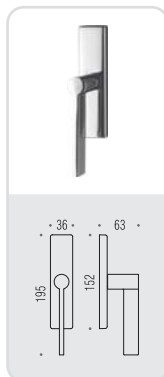

MD 12 DK/SM

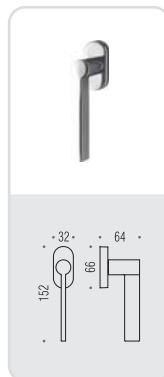

VARIANTI DISPONIBILI
ALSO AVAILABLE



**six millimeters
concept**
maniglie con rosetta e bocchetta
bassa che non necessitano di
lavorazioni aggiuntive sulla porta.
handles with slim rose and
escutcheon don't need additional
installation works on the door.

MD 11 RF-RYF

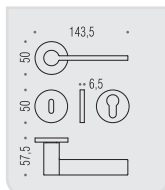

FF 19 BZG 6/8

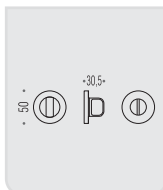

MD 12 DKF/SM

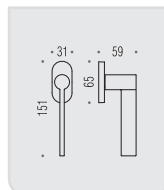



TRAMA

Design: Luca Colombo





trama

Design: Luca Colombo

Materiale: Cromall®
Material: Cromall®



six millimeters
concept

maniglie con rosetta e bocchetta
bassa che non necessitano di
lavorazioni aggiuntive sulla porta,
handles with slim rose and
escutcheon don't need additional
installation works on the door.



CM/CR
Cromat/Cromo
Matt chrome/Chrome

LC 71 R-RY

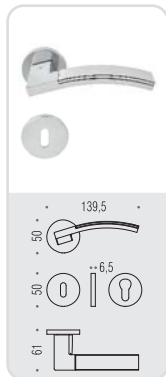

FF 19 BZG 6/8

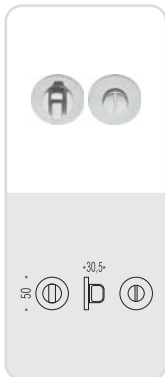

LC 72 IM

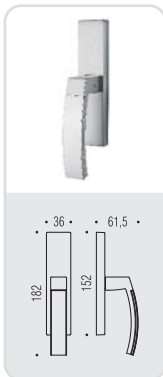

LC 72 DK/SM





TRAMA

Design: Luca Colombo





trama

Design: Luca Colombo

Materiale: Cromall®
Material: Cromall®



six millimeters
concept

maniglie con rosetta e bocchetta
bassa che non necessitano di
lavorazioni aggiuntive sulla porta,
handles with slim rose and
escutcheon don't need additional
installation works on the door.



CM/CR
Cromat/Cromo
Matt chrome/Chrome

LC 81 R-RY

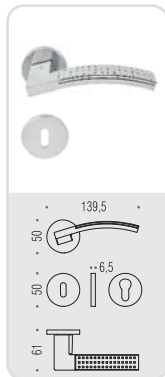

FF 19 BZG 6/8

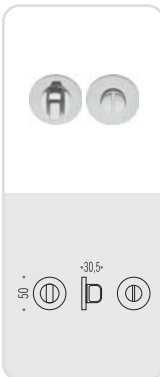

LC 82 IM

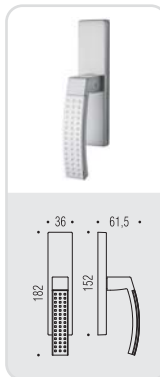

LC 82 DK/SM

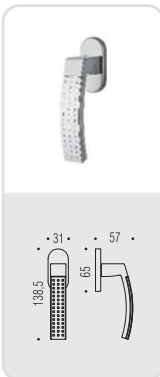



TWITTY

Design: Tomo Kimura





twitty

Design: Tomo Kimura

FREE STYLE
COLLECTION

Materiale: Ottone
Material: Brass



OL
Oroplus



CR
Cromo
Chrome



CM
Cromat
Matt chrome

TK 11 R-RY

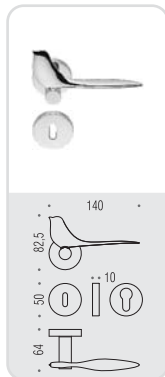

CD 49 BZG G 6/8





VIOLA

Design: Angeletti Ruzza Design





viola

Design: Angeletti Ruzza Design

Materiale: Ottone
Material: Brass



OL
Oroplus



CR
Cromo
Chrome



HPS/1
Zirconium stainless-steel HPS



CM
Cromat
Matt chrome



VL
Vintage

vintage



VM
Vintage Mat

vintage

AR 21 R-RY

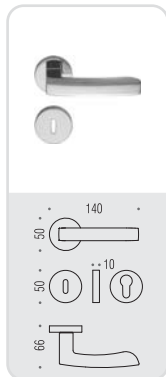

CD 49 BZG G 6/8



AR 22 IM

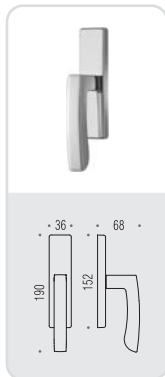

AR 22 DK/SM

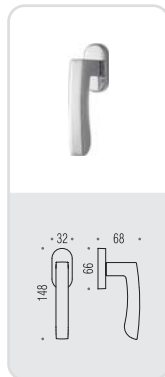



WING

Design: Ottavio Di Blasi





wing

Design: Ottavio Di Blasi

Materiale: Ottone
Material: Brass



OL
Oroplus



CM
Cromat
Matt chrome

DB 31 R-RY

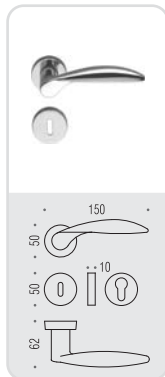

CD 49 BZG G 6/8



DB 32 IM

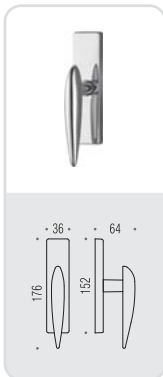

DB 32 DK/SM

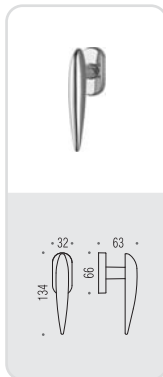



ZELDA

Design: Jean Marie Massaud



MM 11



zelda

Design: Jean Marie Massaud

Materiale: Ottone
Material: Brass



CR
Cromo
Chrome



CM
Cromat
Matt chrome

VERSIONE STANDARD
STANDARD VERSION

MM 11 R-RY

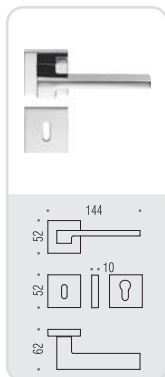

MM 29 BZG 6/8

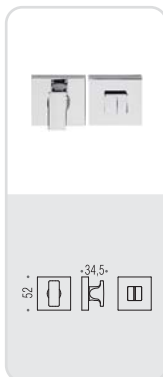

MM 12 IM

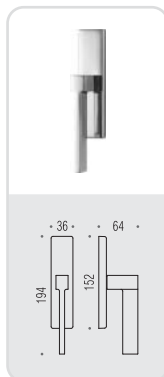

MM 12 DK/SM

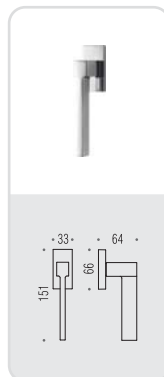

VARIANTI DISPONIBILI
ALSO AVAILABLE

MM 11 RF-RYF

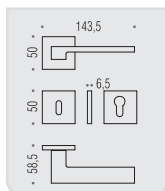

FF 29 BZG 6/8

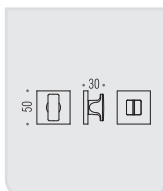

MM 12 DKF/SM

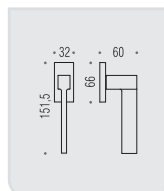

**six millimeters
concept**

maniglie con rosetta e bocchetta
bassa che non necessitano di
lavorazioni aggiuntive sulla porta.
handles with slim rose and
escutcheon don't need additional
installation works on the door.



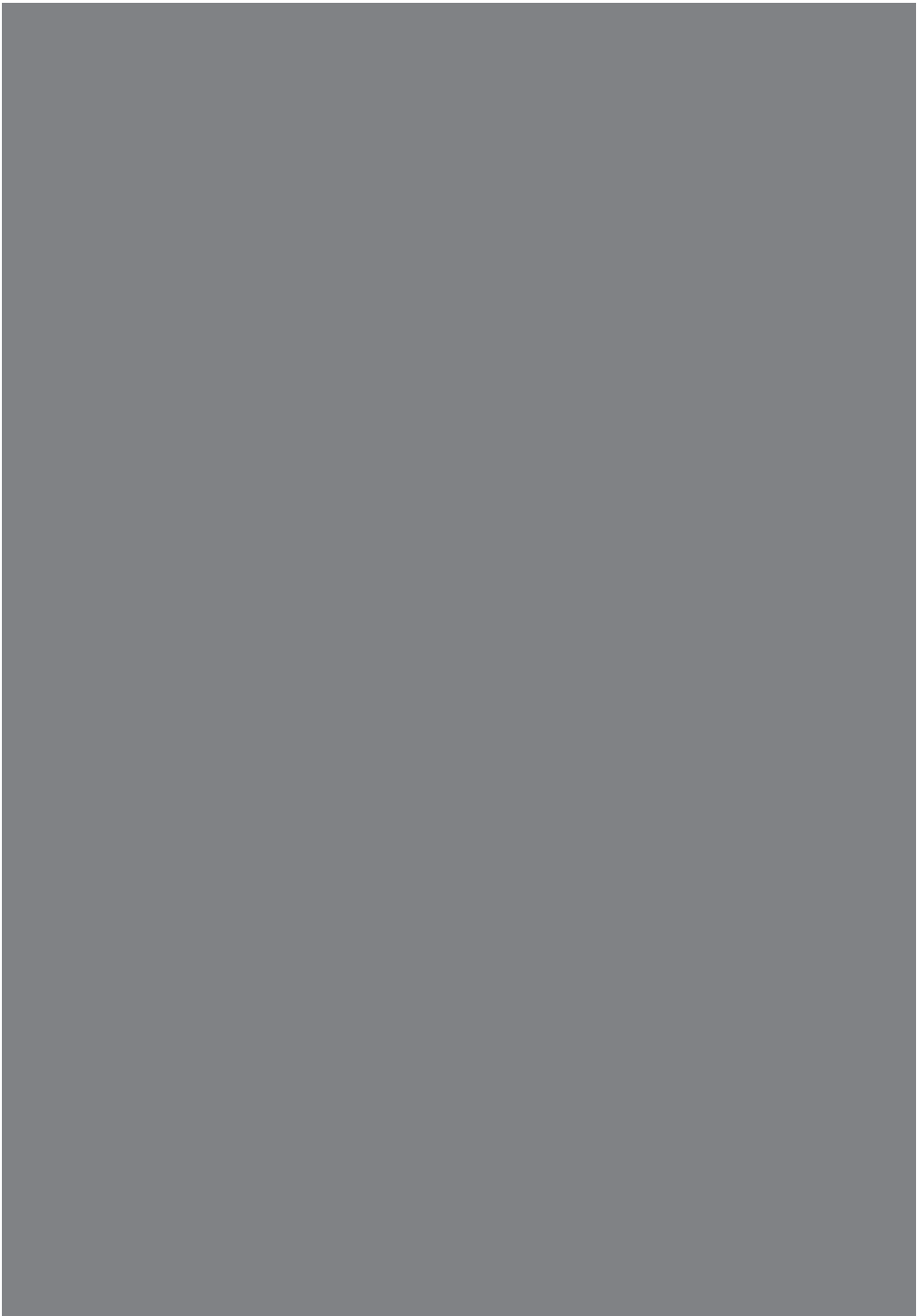

Classic Line

predaj a technická podpora: AROSE s.r.o. / RAČIANSKA 97 / BRATISLAVA / 831 02 / TEL: +421 911 555 454 / E-MAIL: arose@arose.sk

CAMEO

Design: Ottavio Di Blasi





cameo

Design: Ottavio Di Blasi

Materiale: Ottone
Material: Brass



OL
Oroplus



CR
Cromo
Chrome



BR
Bronzo
Bronze

DB 41 P-PY

OL CR BR

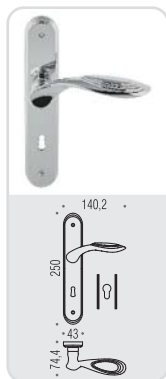

DB 41 R-RY

OL CR BR



DB 19 BZG 6/8

OL CR BR



DB 42 IM

OL CR BR

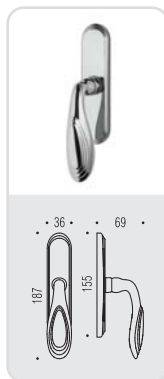

DB 42 DK/SM

OL CR BR

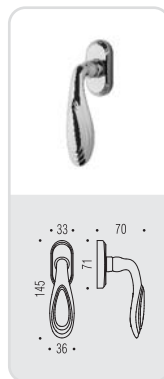



HEIDI

Design: Colombo Design





heidi

Design: Colombo Design

Materiale: Ottone
Material: Brass



OL
Oropius



BR
Bronzo
Bronze

CD 31 P-PY

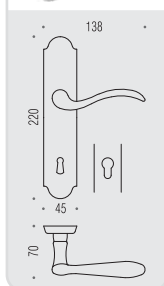

CD 31 R-RY

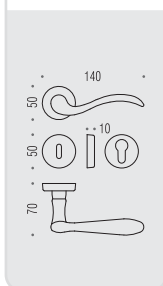

CD 69 BZG G 6/8

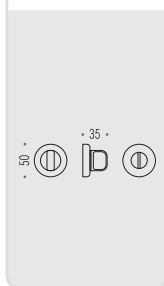

CD 32 M

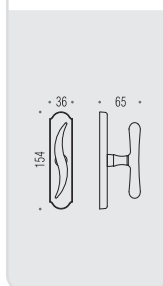
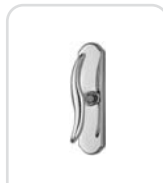

CD 32 DK/SM DX-SX

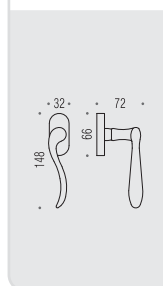



IDA

Design: Colombo Design





ida

Design: Colombo Design

Materiale: Ottone
Material: Brass



OL
Oroplus



CR
Cromo
Chrome



BR
Bronzo
Bronze



OA
Ottone antico
Antique brass



BA
Bronzo antico
Antique bronze

ID 31 P-PY

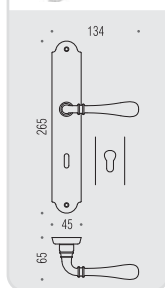

ID 31 R-RY

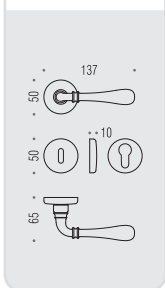

CD 69 BZG G 6/8



ID 32 M

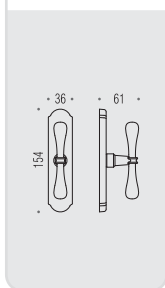
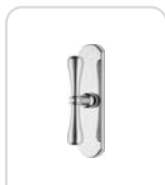

ID 32 DK/SM

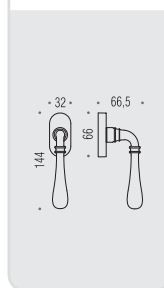



PETER

Design: Colombo Design





peter

Design: Colombo Design

Materiale: Ottone
Material: Brass



OL
Oroplus



OM
Oromat
Matt gold



BR
Bronzo
Bronze



OA
Ottone antico
Antique brass

ID 11 P-PY

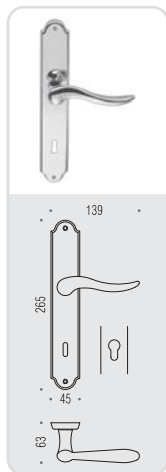

ID 11 R-RY

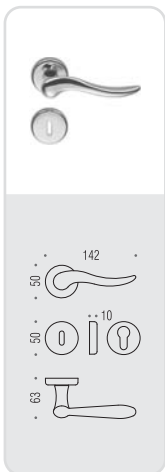

CD 69 BZG G 6/8

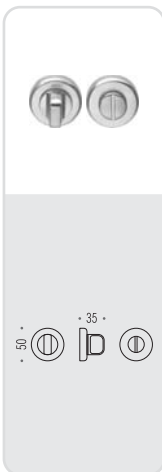

CD 32 M

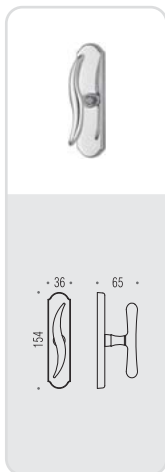

ID 12 DK/SM DX-SX

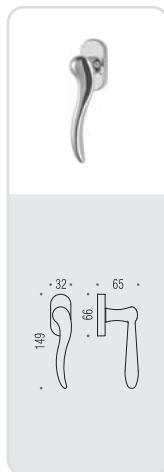



PIUMA

Design: Angeletti Ruzza Design





piuma

Design: Angeletti Ruzza Design

Materiale: Ottone
Material: Brass



OL
Oroplus



BR
Bronzo
Bronze

AR 11 P-PY

OL BR

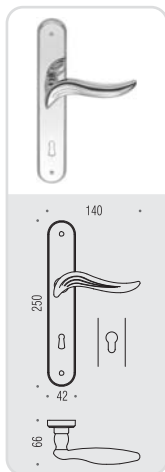

AR 11 R-RY

OL BR

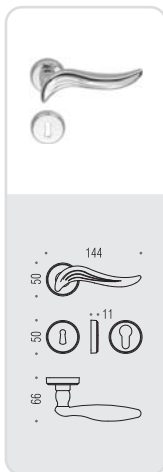

CD 79 BZG 6/8

OL BR



AR 12 M

OL BR

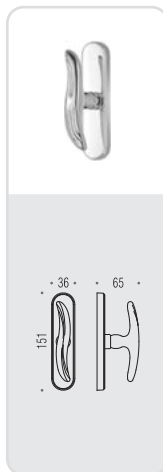

AR 12 DK/SM

OL BR

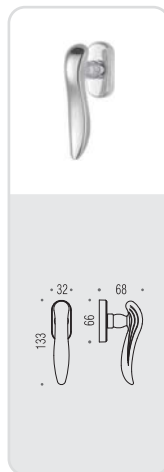



ROBOT



ROBODUE



ROBOTRE



ROBOQUATTRO

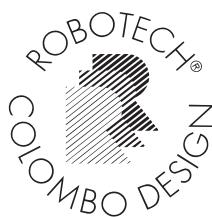

ROBOQUATTRO_S



ROBOCINQUE



ROBOCINQUE_S



ROBOTECH®

predaj a technická podpora: AROSE s.r.o. / RAČIANSKA 97 / BRATISLAVA / 831 02 / TEL: +421 911 555 454 / E-MAIL: arose@arose.sk

MACH

Design: Colombo Design





mach

Design: Colombo Design



Materiale: Cromall®/Ottone
Material: Cromall®/Brass



HPS
Zirconium gold HPS



CM
Cromat
Matt chrome



OL
Oroplus



NI
Nikelmat
Matt nickel



OM
Oromat
Matt gold



OA
Ottone antico
Antique brass

CD 81 P-PY



CD 81 R-RY



CD 69 BZG G 6/8



CD 82 IM



CD 82 DK/SM

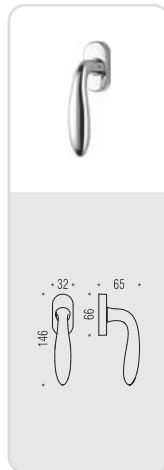
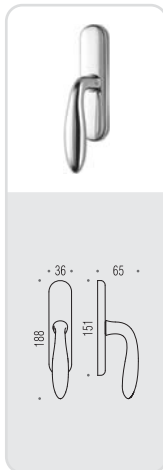
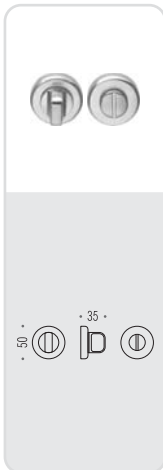
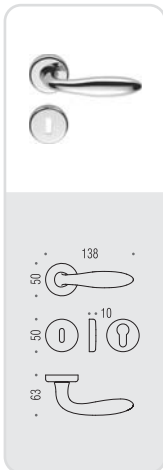
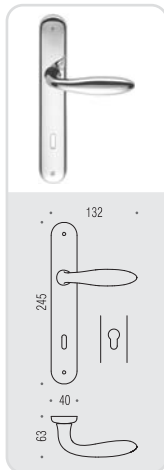



ROBOT

Design: Colombo Design





robot

Design: Colombo Design



Materiale: Cromall®
Material: Cromall®



OL
Oroplus



CR
Cromo
Chrome



NM
Neromat
Matt black



CM
Cromat
Matt chrome



BI
Biancomat
Matt white



CD 41 P-PY



CD 41 R-RY



CD 69 BZG 6/8



CD 42 M



CD 42 IM



CD 42 DK/SM



CD 42 DK Z

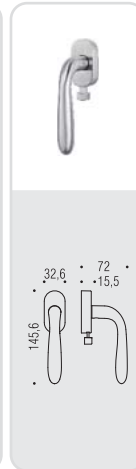
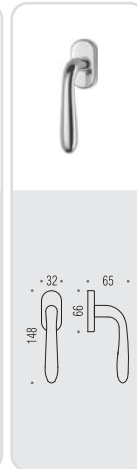
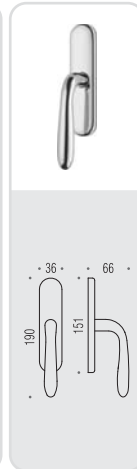
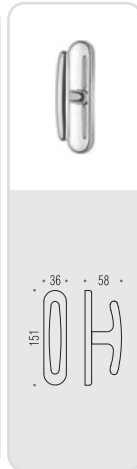
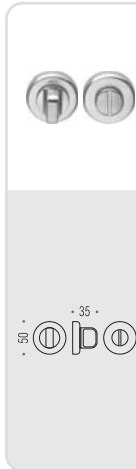
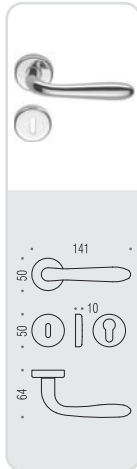
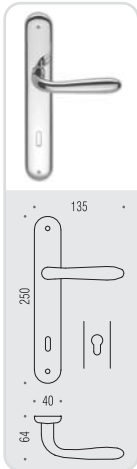



ROBOT

Design: Colombo Design





robot

Design: Colombo Design



Materiale: Ottone
Material: Brass



HPS
Zirconium gold HPS



OM
Oromat
Matt gold



CM
Cromat
Matt chrome



CR
Cromo
Chrome



BR
Bronzo
Bronze

CD 75 R-RY



CD 69 BZG 6/8

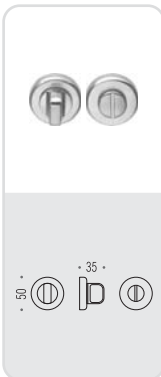
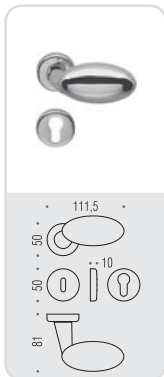



ROBODUE

Design: Colombo Design





robodue

Design: Colombo Design



Materiale: Cromall®
Material: Cromall®



OL
Oroplus



CR
Cromo
Chrome



CM
Cromat
Matt chrome

CD 51 P-PY

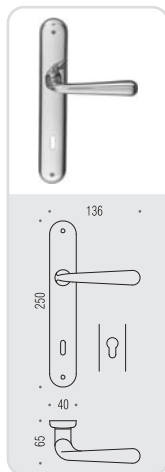

CD 51 R-RY

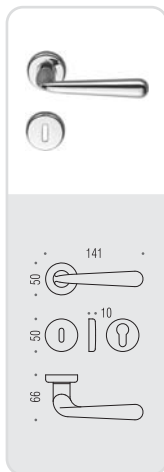

CD 69 BZG 6/8



CD 52 M



CD 52 DK/SM

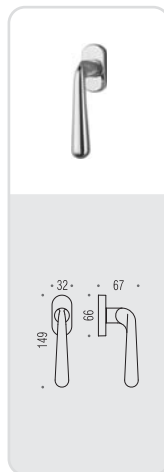



ROBOTRE

Design: Colombo Design





robotre

Design: Colombo Design



Materiale: Cromall®/Ottone
Material: Cromall®/Brass



HPS
Zirconium gold HPS



CR
Cromo
Chrome



OL
Oroplus



CM
Cromat
Matt chrome



OM
Oromat
Matt gold



BR
Bronzo
Bronze



CD 91 P-PY



CD 91 R-RY



CD 69 BZG G 6/8



CD 92 IM



CD 92 DK/SM



CD 92 DK Z

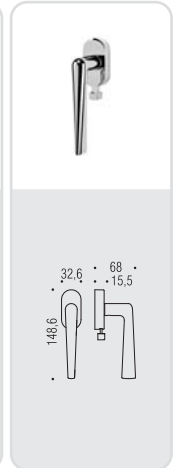
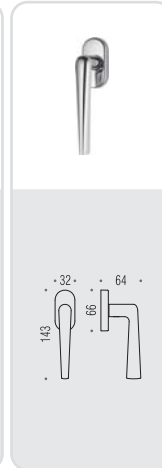
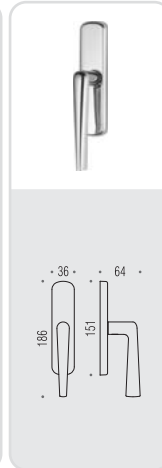
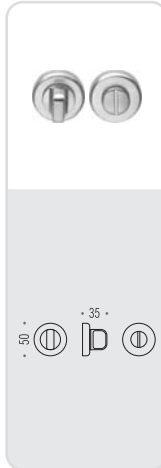
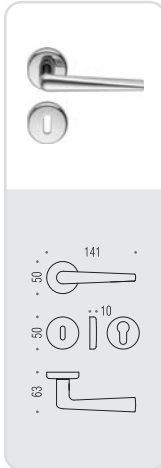
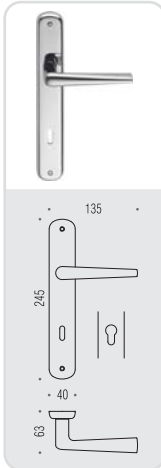



ROBOQUATTRO

Design: Colombo Design





roboquattro

Design: Colombo Design

Materiale: Cromall®
Material: Cromall®



OL
Oropius



OM
Oromat
Matt gold



CR
Cromo
Chrome



CM
Cromat
Matt chrome



ID 41 R-RY

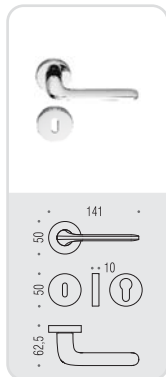

CD 49 BZG G 6/8



ID 42 IM

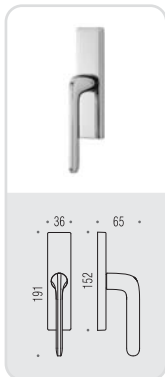

ID 42 DK/SM

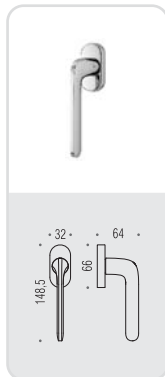

ID 42 DK Z

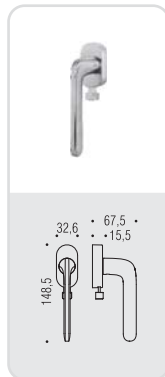



ROBOQUATTRO *S*

Design: Colombo Design



ID 51



roboquattro_s

Design: Colombo Design

Materiale: Cromall®
Material: Cromall®



OL
Oroplus



CR
Cromo
Chrome



CM
Cromat
Matt chrome



VL
Vintage

vintage



VM
Vintage Mat

vintage



ID 51 R-RY

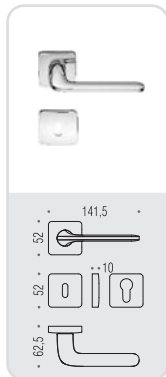

PT 19 BZG 6/8

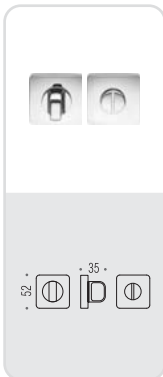

ID 42 IM

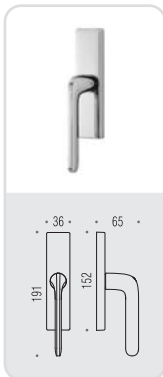

ID 52 DK/SM

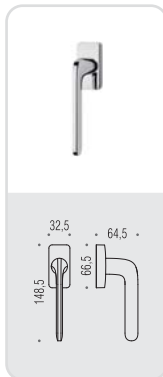

ID 52 DK Z

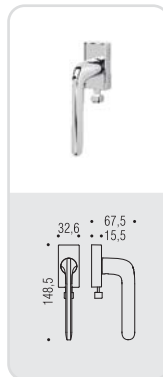



ROBOCINQUE

Design: Colombo Design





robocinque

Design: Colombo Design



Materiale: Cromall®
Material: Cromall®



OL
Oroplus



CR
Cromo
Chrome



CM
Cromat
Matt chrome



NM
Neromat
Matt black



BI
Biancomat
Matt white



ID 61 R-RY

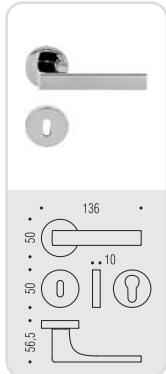

CD 49 BZG G 6/8



ID 62 IM

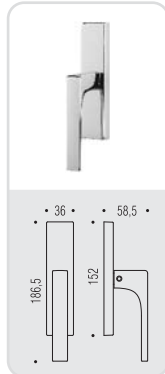

ID 62 DK/SM

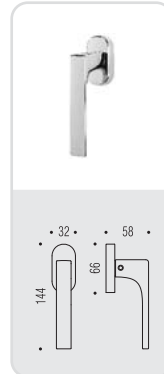

ID 62 DK Z

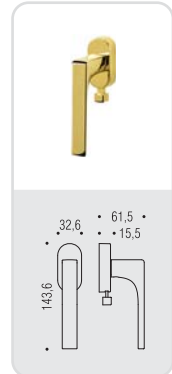



ROBOCINQUE *S*

Design: Colombo Design



ID 71



robocinque_S

Design: Colombo Design



Materiale: Cromall®
Material: Cromall®



CR
Cromo
Chrome



NM
Neromat
Matt black



CM
Cromat
Matt chrome



BI
Biancomat
Matt white



GL
Grafito
Graphite



GM
Grafito Mat
Matt graphite



ID 71 R-RY

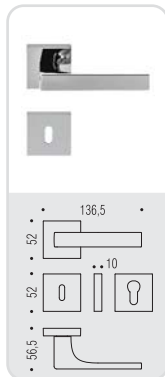

MM 29 BZG 6/8



ID 62 IM

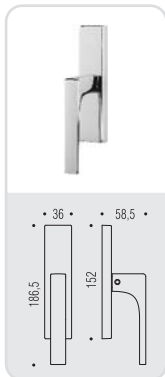

ID 72 DK/SM

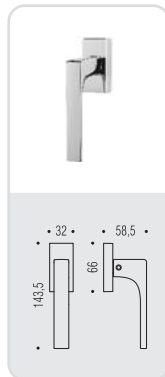

ID 72 DK Z

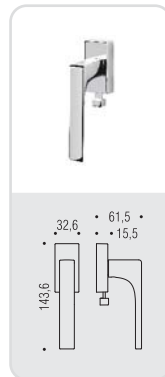



predaj a technická podpora: AROSE s.r.o. / RAČIANSKA 97 / BRATISLAVA / 831 02 / TEL: +421 911 555 454 / E-MAIL: arose@arose.sk

POMOLI

DOOR KNOBS

predaj a technická podpora: AROSE s.r.o. / RAČIANSKA 97 / BRATISLAVA / 831 02 / TEL: +421 911 555 454 / E-MAIL: arose@arose.sk

bold

Design: Pio e Tito Toso lab

Materiale: Ottone
Material: Brass



CR
Cromo
Chrome



CM
Cromat
Matt chrome

PT 15

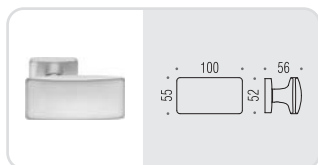

cut

Design: Messineo e Settimelli

Materiale: Cromall®/Ottone
Material: Cromall®/Brass



CR
Cromo
Chrome



CM
Cromat
Matt chrome

MS 15

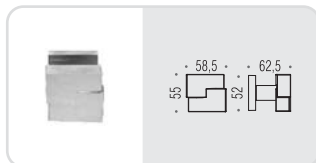

MS 25

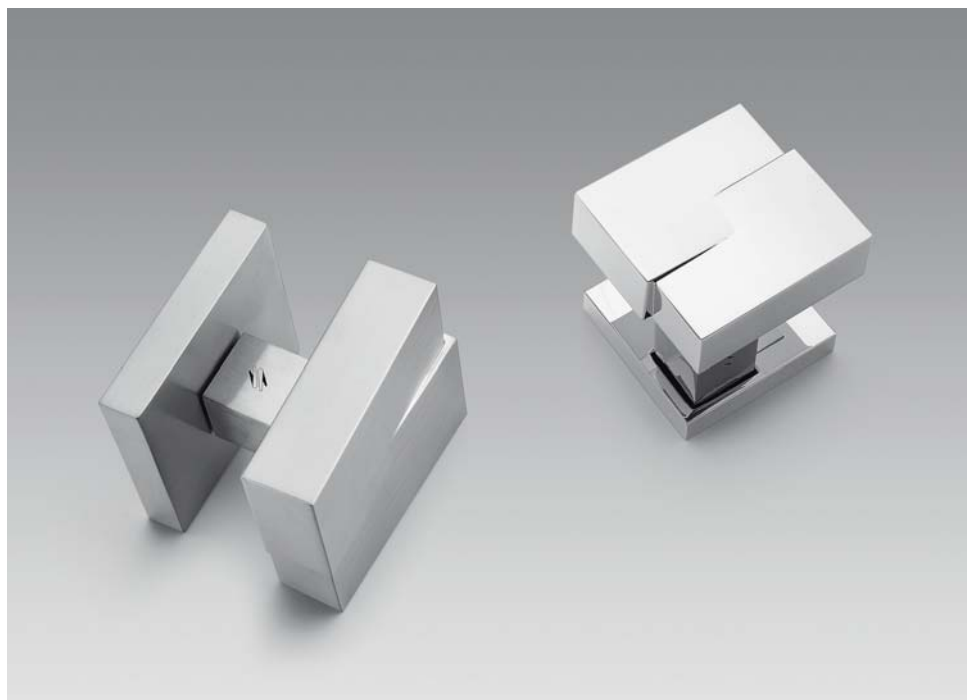
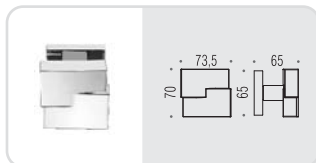

daytona

Design: *pininfarina*

Materiale: Ottone
Material: Brass



HPS
Zirconium
gold HPS



CM
Cromat
Matt chrome

PF 15

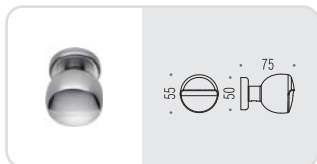

drop

Design: Luca Colombo

Materiale: Ottone
Material: Brass



HPS
Zirconium
gold HPS



CR
Cromo
Chrome



CM
Cromat
Matt chrome

BR
Bronzo
Bronze

LC 45

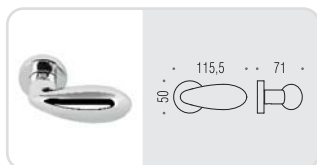

etro

Design: Di Blasi Associati

Materiale: Ottone
Material: Brass



OL/OM
Oroplus/Oromat
Oroplus/Matt gold



CR/CM
Cromo/Cromat
Chrome/Matt chrome

DB 15

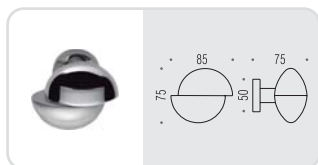

mapo

Design: Mauro Ronchi

Materiale: Ottone
Material: Brass



RM 15



moon

Design: Bartoli Design

Materiale: Ottone
Material: Brass



HPS
Zirconium
gold HPS



CR
Cromo
Chrome



CM
Cromat
Matt chrome

BD 15

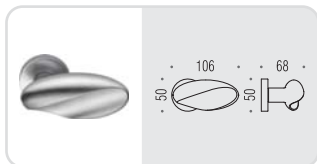

push

Design: Luca Colombo

Materiale: Ottone
Material: Brass



HPS
Zirconium
gold HPS



CR
Cromo
Chrome



CM
Cromat
Matt chrome

LC 55

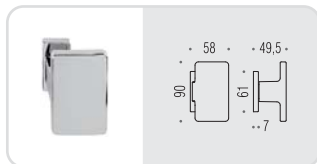

robot

Design: Colombo Design



Materiale: Ottone
Material: Brass



HPS
Zirconium
gold HPS



OL
Oroplus



OM
Oromat
Matt gold



CR
Cromo
Chrome



CM
Cromat
Matt chrome

NI
Nikelmat
Matt nickel

BR
Bronzo
Bronze

BA
Bronzo antico
Antique bronze

OA
Ottone antico
Antique brass

CD 45



CD 55



CD 65

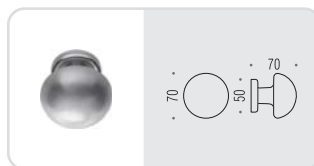

robot

Design: Colombo Design



Materiale: Ottone
Material: Brass



HPS
Zirconium
gold HPS



OM
Oromat
Matt gold



CR
Cromo
Chrome



CM
Cromat
Matt chrome

BR
Bronzo
Bronze

CD 75

HPS OM CR CM BR

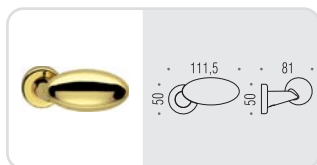

round

Design: Colombo Design

Materiale: Ottone
Material: Brass



OL
Oroplus



CR
Cromo
Chrome



CM
Cromat
Matt chrome

ID 25



ID 35

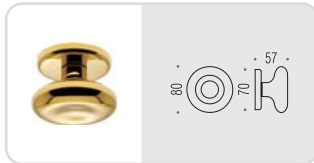

spider

Design: Matteo Ragni

Materiale: Ottone
Material: Brass



CR
Cromo
Chrome



CM
Cromat
Matt chrome

MR 15

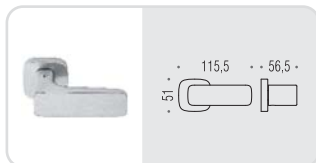

square

Design: Luca Colombo

Materiale: Ottone
Material: Brass



CR
Cromo
Chrome



CM
Cromat
Matt chrome



VL
Vintage



VM
Vintage Mat

LC 15

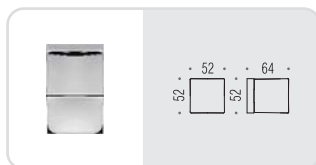

LC 25

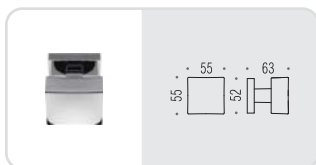

LC 35

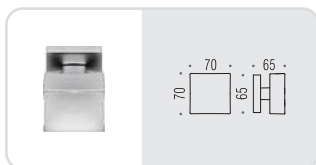

MANIGLIONI E BATTENTI

PULLS AND
DOOR KNOCKERS

predaj a technická podpora: AROSE s.r.o. / RAČIANSKA 97 / BRATISLAVA / 831 02 / TEL: +421 911 555 454 / E-MAIL: arose@arose.sk

daytona

Design: *pininfarina*

MANIGLIONI SENZA ROSETTE
PULLS WITHOUT ROSES

Materiale: Ottone
Material: Brass



HPS
Zirconium
gold HPS



CM
Cromat
Matt chrome

PF 16

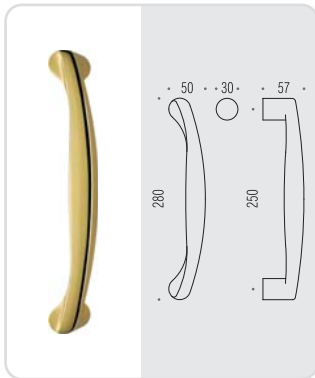

elle

Design: **TEAM 3**

MANIGLIONI SENZA ROSETTE
PULLS WITHOUT ROSES

Materiale: Cromall®
Material: Cromall®



HPS/1
Zirconium
stainless-steel HPS



CR
Cromo
Chrome



CM
Cromat
Matt chrome

ID 36

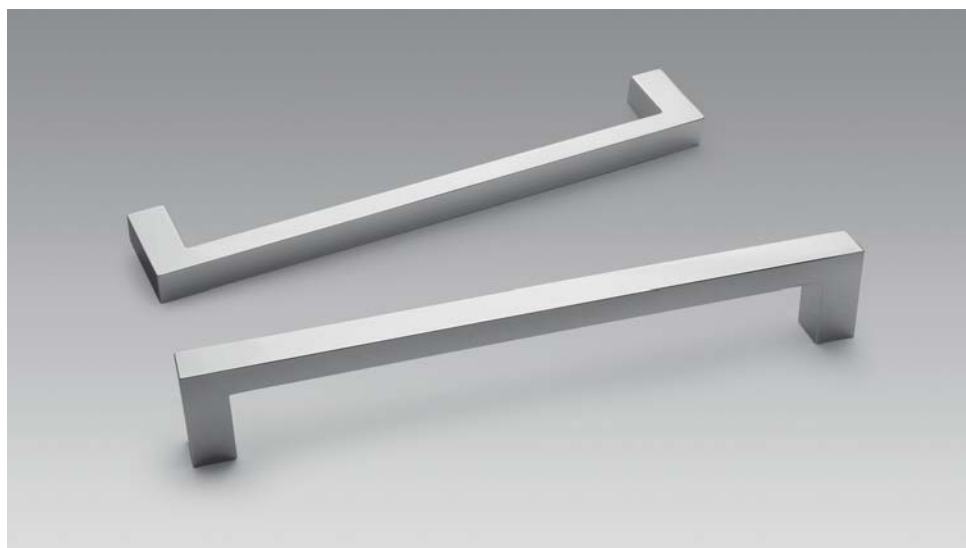
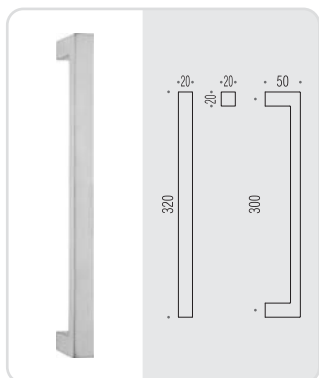

five

MANIGLIONI SENZA ROSETTE
PULLS WITHOUT ROSES

Design: Colombo Design

Materiale: Ottone
Material: Brass



OL
Oroplus



CR
Cromo
Chrome



CM
Cromat
Matt chrome



GL
Grafite
Graphite



GM
Grafite Mat
Matt graphite



NM
Neromat
Matt black



BI
Biancomat
Matt white

ID 56

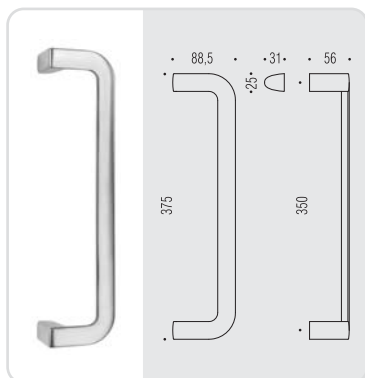

flesso

Design: Carlo Bartoli

MANIGLIONI SENZA ROSETTE
PULLS WITHOUT ROSES

Materiale: Ottone
Material: Brass



HPS
Zirconium
gold HPS



OL
Oroplus



OM
Oromat
Matt gold



CR
Cromo
Chrome



CM
Cromat
Matt chrome

NM
Neromat
Matt black

CB 16 Z/A

HPS OL OM CR CM NM

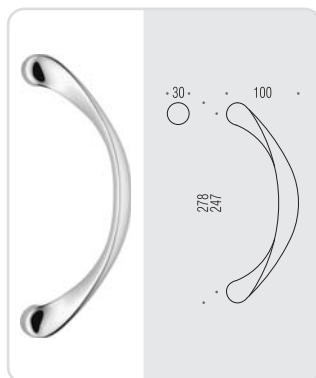

CB 16 Z/B

HPS OL OM CR CM NM

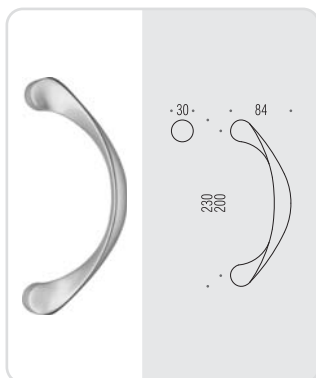

logo

Design: Luca Colombo

MANIGLIONI SENZA ROSETTE
PULLS WITHOUT ROSES

Materiale: Ottone
Material: Brass



HPS
Zirconium
gold HPS



OL
Oroplus



CR
Cromo
Chrome



CM
Cromat
Matt chrome

LC 16

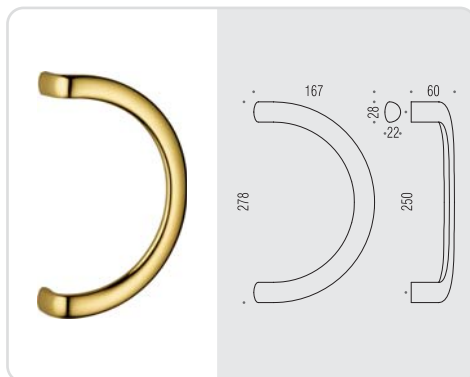

LC 16 L

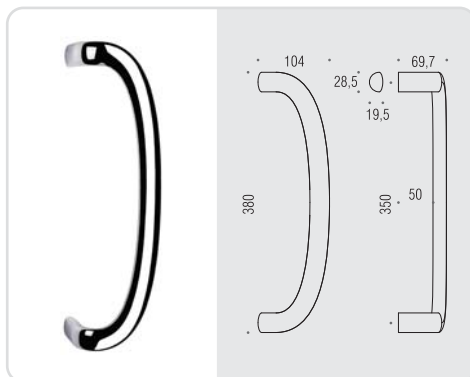

lund

Design: Claesson Koivisto Rune

MANIGLIONI SENZA ROSETTE
PULLS WITHOUT ROSES

Materiale: Ottone
Material: Brass



CR
Cromo
Chrome



CM
Cromat
Matt chrome



GL
Grafite
Graphite



GM
Grafite Mat
Matt graphite

SE 16

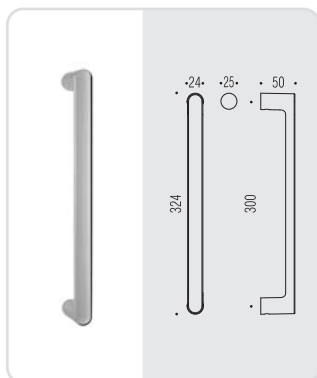

noa

Design: **TEAM 3**

MANIGLIONI SENZA ROSETTE
PULLS WITHOUT ROSES

Materiale: Ottone
Material: Brass



HPS
Zirconium
gold HPS

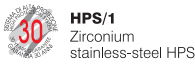

HPS/1
Zirconium
stainless-steel HPS



CR
Cromo
Chrome



CM
Cromat
Matt chrome

ID 16 A

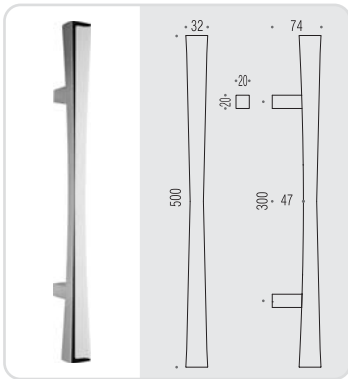

ID 16 B

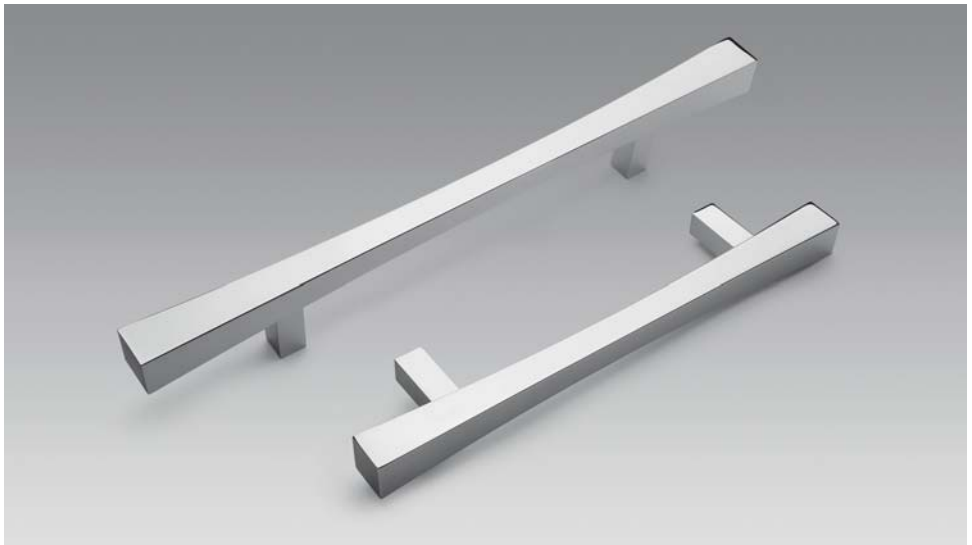
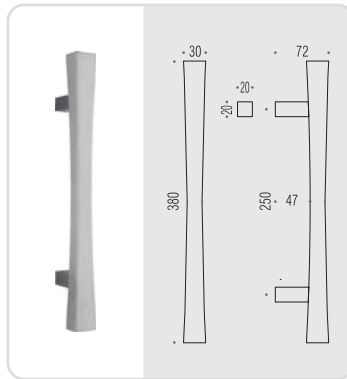

noa

Design: **TEAM 3**

MANIGLIONI SENZA ROSETTE
PULLS WITHOUT ROSES

Materiale: Ottone
Material: Brass



ID 26 A

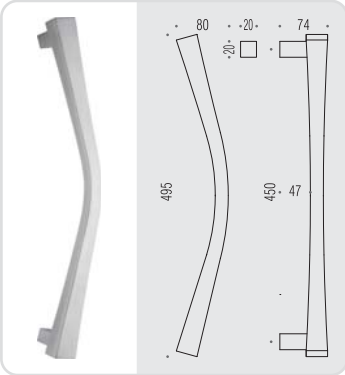

ID 26 B

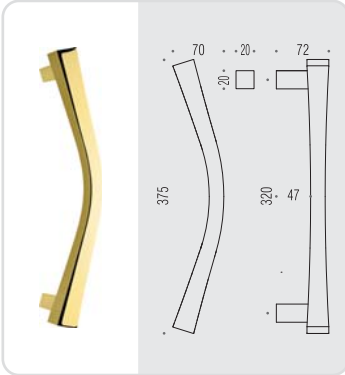

roboquattro

Design: Colombo Design

MANIGLIONI SENZA ROSETTE
PULLS WITHOUT ROSES

Materiale: Ottone
Material: Brass



HPS
Zirconium
gold HPS



OL
Oroplus



OM
Oromat
Matt gold



CR
Cromo
Chrome



CM
Cromat
Matt chrome

ID 46 A

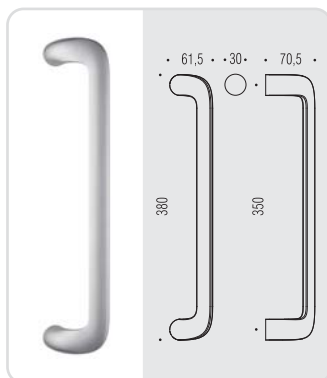

ID 46 B

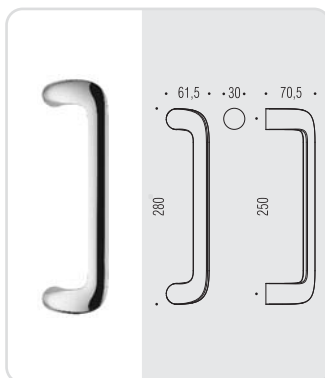

square

Design: Architettura Laboratorio

MANIGLIONI SENZA ROSETTE
PULLS WITHOUT ROSES

Materiale: Ottone
Material: Brass



HPS
Zirconium
gold HPS



HPS/1
Zirconium
stainless-steel HPS



CM
Cromat
Matt chrome



VL
Vintage



VM
Vintage Mat

MG 26

HPS HPS1 CM VL VM

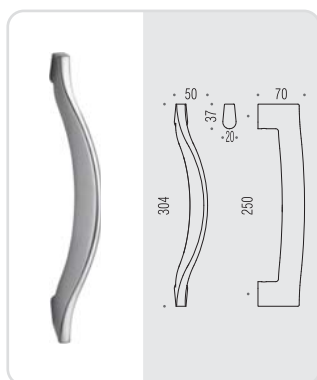

tender

Design: Architettura Laboratorio

MANIGLIONI SENZA ROSETTE
PULLS WITHOUT ROSES

Materiale: Ottone
Material: Brass



HPS
Zirconium
gold HPS



OL
Oroplus



OM
Oromat
Matt gold



CR
Cromo
Chrome



CM
Cromat
Matt chrome

NI
Nikelmat
Matt nickel

BA
Bronzo antico
Antique bronze

OA
Ottone antico
Antique brass



NM
Neromat
Matt black

MG 16

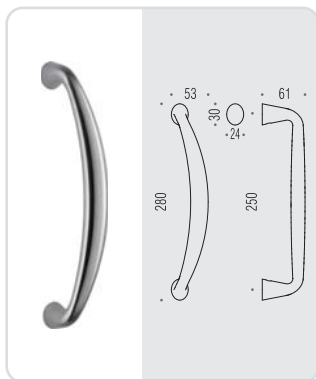

MG 16 L

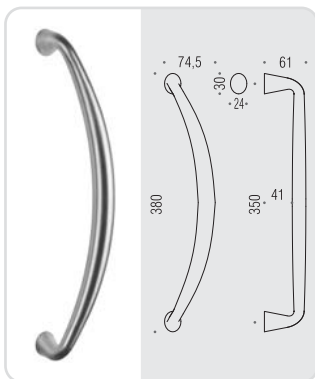

wave

Design: Marco Piva

MANIGLIONI SENZA ROSETTE
PULLS WITHOUT ROSES

Materiale: Ottone
Material: Brass



HPS/1
Zirconium
stainless-steel HPS



CM
Cromat
Matt chrome

MP 16 A

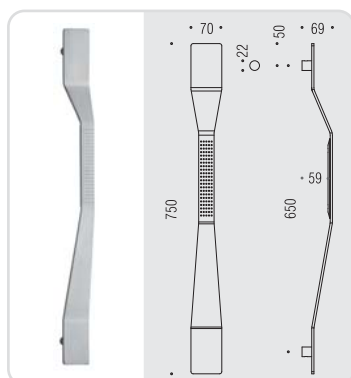

MP 16 B

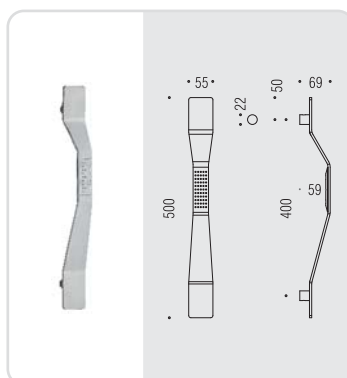

zen

Design: Bartoli Design

MANIGLIONI SENZA ROSETTE
PULLS WITHOUT ROSES

Materiale: Ottone
Material: Brass



CB 36 A

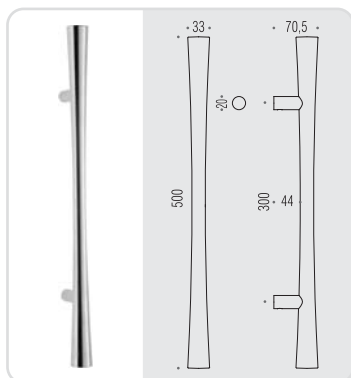

CB 36 B

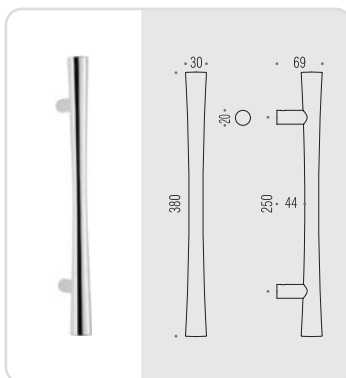

zen

Design: Bartoli Design

MANIGLIONI SENZA ROSETTE
PULLS WITHOUT ROSES

Materiale: Ottone
Material: Brass



CB 46 A

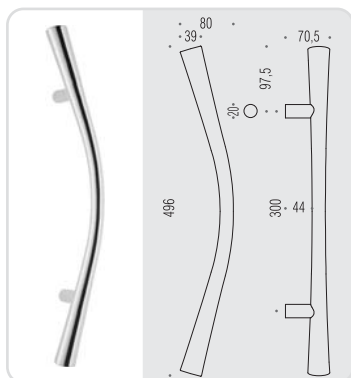

CB 46 B

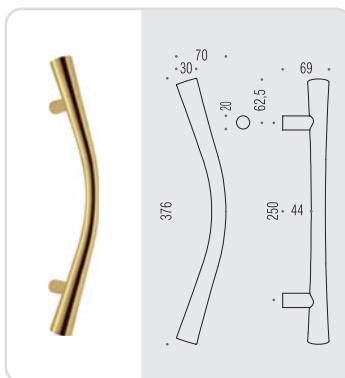

blues

Design: Colombo Design

MANIGLIONI SENZA ROSETTE
PULLS WITHOUT ROSES

Materiale: Ottone
Material: Brass



OL
Oroplus



CR
Cromo
Chrome



CM
Cromat
Matt chrome

CD 36

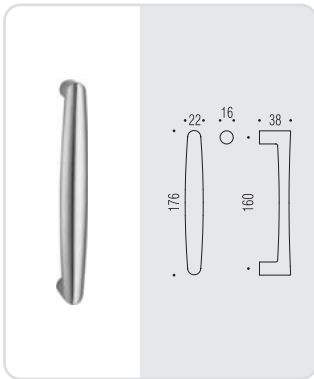

jazz

Design: Bartoli Design

MANIGLIONI SENZA ROSETTE
PULLS WITHOUT ROSES

Materiale: Ottone
Material: Brass



CD 26

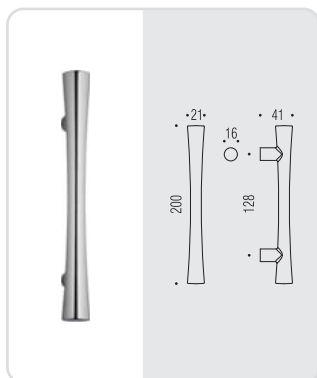

nice

Design: Carlo Bartoli

MANIGLIONI CON ROSETTE
PULLS WITH ROSES

Materiale: Ottone
Material: Brass



HPS
Zirconium
gold HPS



OL
Oroplus



CM/CR
Cromat/Cromo
Matt chrome/Chrome

CB 26

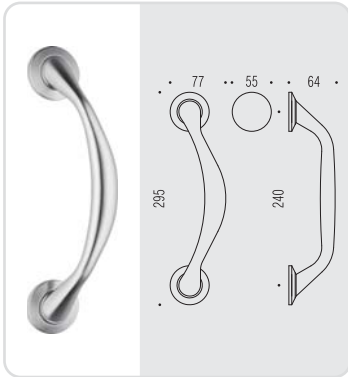

piuma

Design: Angeletti Ruzza Design

MANIGLIONI CON ROSETTE
PULLS WITH ROSES

Materiale: Ottone
Material: Brass



OL
Oroplus

BR
Bronzo
Bronze

AR 16

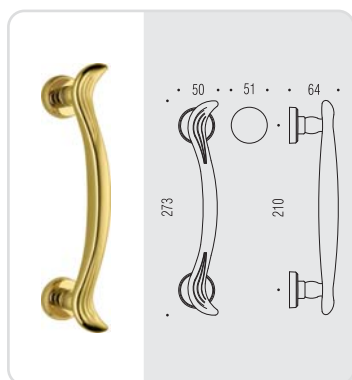

robot

Design: Colombo Design

MANIGLIONI CON ROSETTE
PULLS WITH ROSES



Materiale: Ottone
Material: Brass



OL
Oroplus



CM
Cromat
Matt chrome

CD 16 A

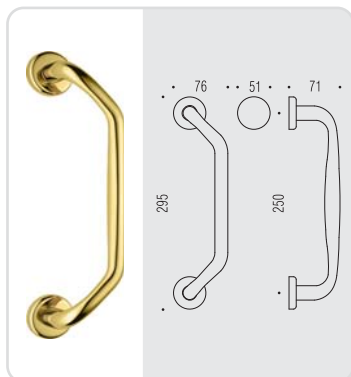

CD 16 B

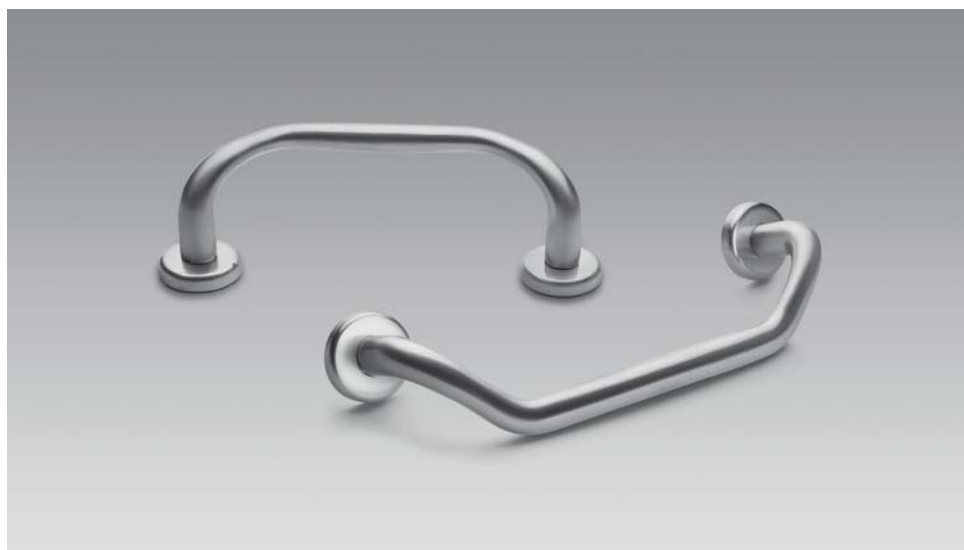
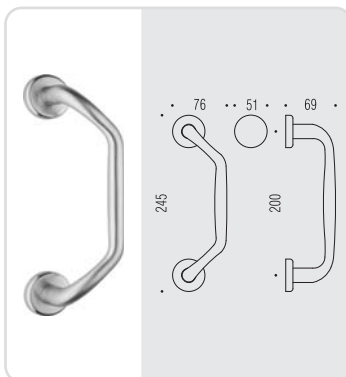

cloud

Design: Luca Colombo

MANIGLIONI PER ANTE IN VETRO
PULLS FOR GLASS DOOR

Materiale: Ottone
Material: Brass



HPS/1
Zirconium
stainless-steel HPS



CR
Cromo
Chrome



CM
Cromat
Matt chrome

LC 26

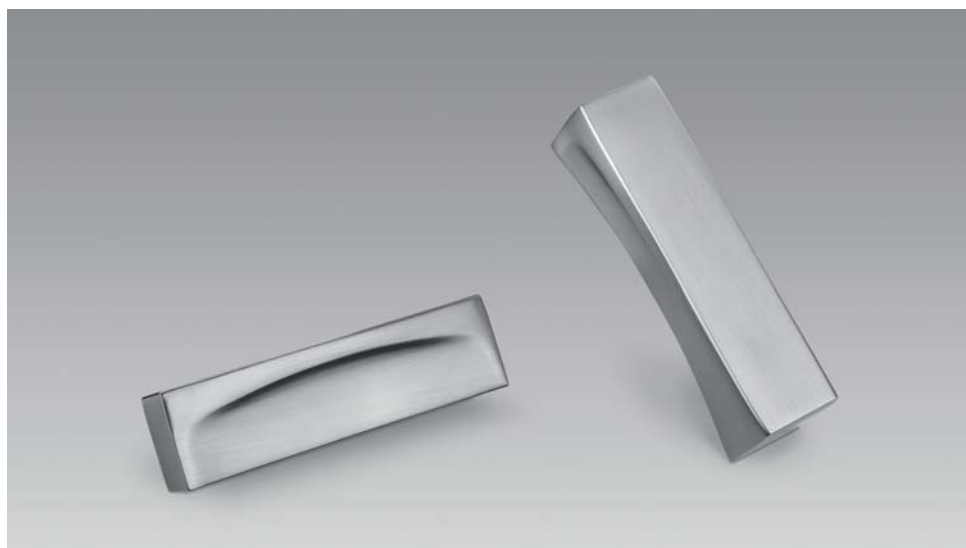
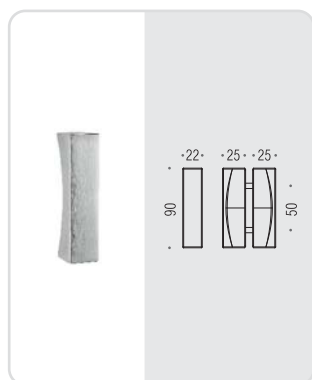

wind

Design: Luca Colombo

MANIGLIONI PER ANTE IN VETRO
PULLS FOR GLASS DOOR

Materiale: Ottone
Material: Brass



CR
Cromo
Chrome



CM
Cromat
Matt chrome

LC 36

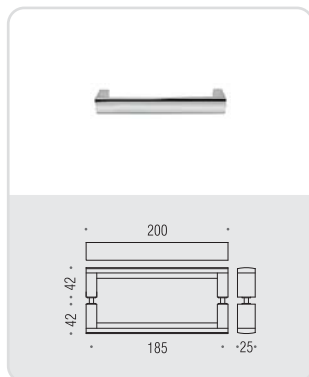

LC 46

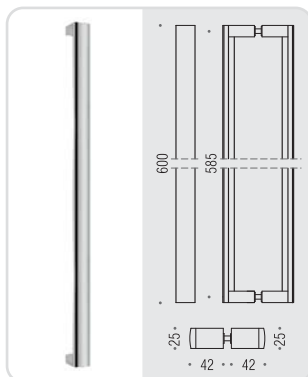

LC 56

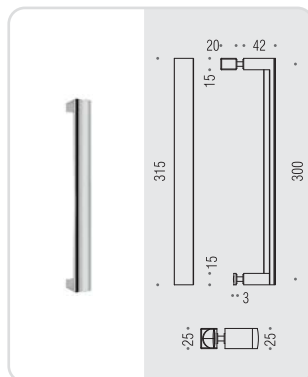

am113/213y

Design: Alberto Meda

MANIGLIONI PER ALZANTE SCORREVOLE
PULL-UP HANDLES FOR SLIDING DOOR

Materiale: Ottone
Material: Brass



AM 113

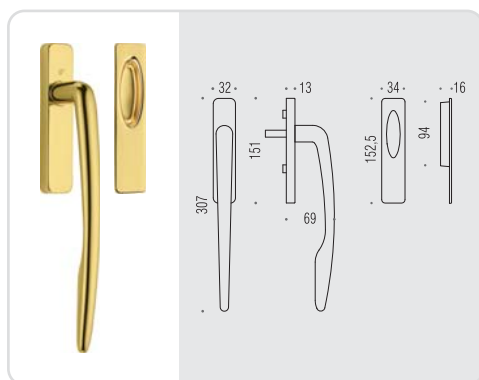

AM 213 Y

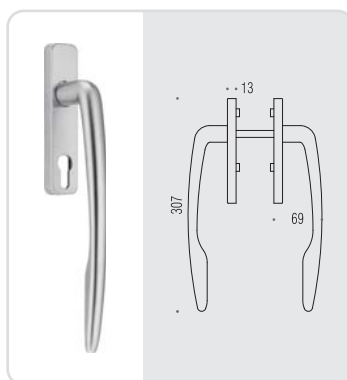

id113/213y

Design: Colombo Design

MANIGLIONI PER ALZANTE SCORREVOLE
PULL-UP HANDLES FOR SLIDING DOOR

Materiale: Ottone
Material: Brass



ID 113

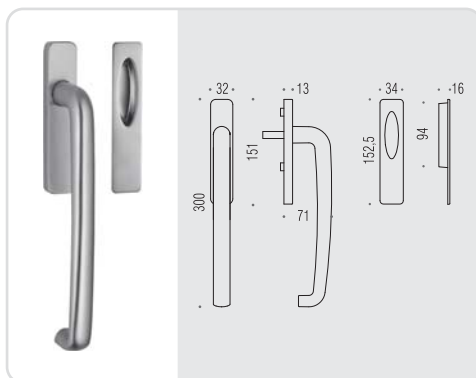

ID 213 Y

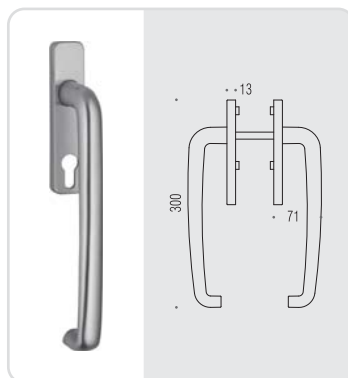

id313/413y

Design: Colombo Design

MANIGLIONI PER ALZANTE SCORREVOLE
PULL-UP HANDLES FOR SLIDING DOOR

Materiale: Ottone
Material: Brass



OL
Oroplus



OM
Oromat
Matt gold



CR
Cromo
Chrome



CM
Cromat
Matt chrome



VM
Vintage Mat

ID 313

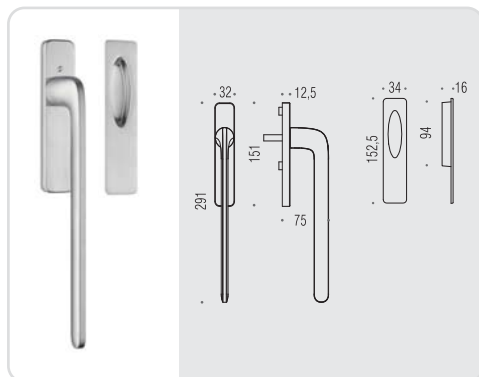

ID 413 Y

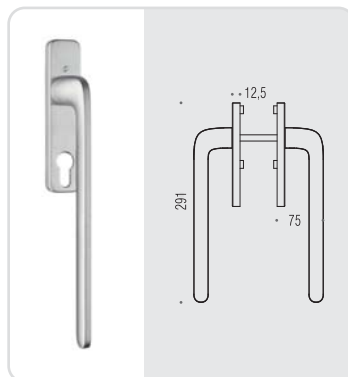

id513/613y

Design: Colombo Design

MANIGLIONI PER ALZANTE SCORREVOLE
PULL-UP HANDLES FOR SLIDING DOOR

Materiale: Ottone
Material: Brass



ID 513

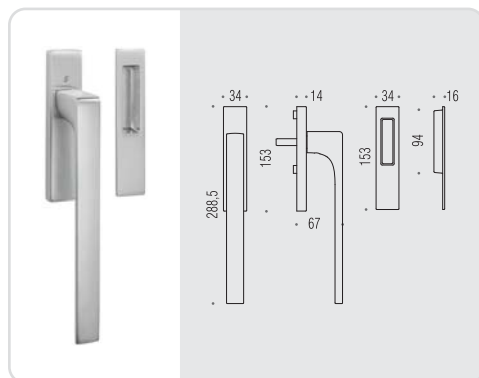

ID 613 Y

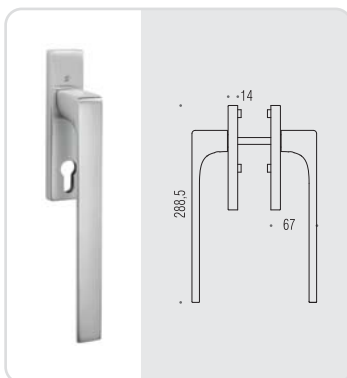

lc113/213y

Design: Luca Colombo

MANIGLIONI PER ALZANTE SCORREVOLE
PULL-UP HANDLES FOR SLIDING DOOR

Materiale: Ottone
Material: Brass



CR
Cromo
Chrome



CM
Cromat
Matt chrome

LC 113

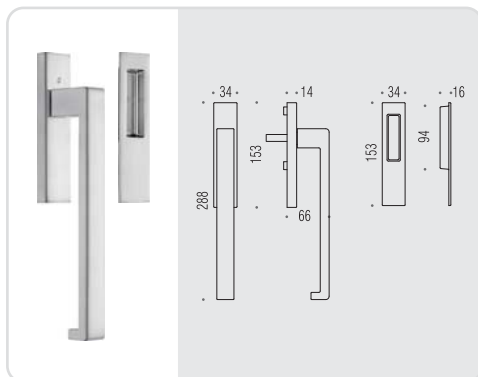

LC 213 Y

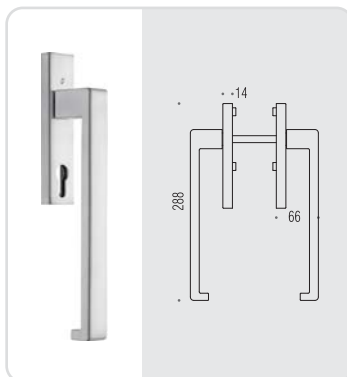

lc413 / 513y

Design: Luca Colombo

MANIGLIONI PER ALZANTE SCORREVOLI
PULL-UP HANDLES FOR SLIDING DOOR

Materiale: Ottone
Material: Brass



CR/CM
Cromo/Cromat
Chrome/Matt chrome



GL/GM
Grafito/Grafito Mat
Graphite/Matt graphite

LC 413

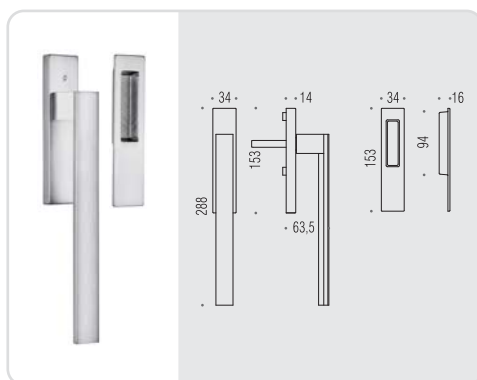

LC 513 Y

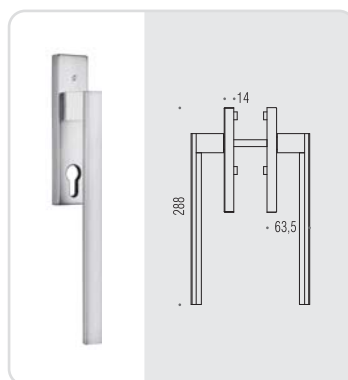

cd113 mignon

Design: Colombo Design

MANIGLIONI PER ALZANTE SCORREVOLE
PULL-UP HANDLES FOR SLIDING DOOR

Materiale: Ottone
Material: Brass



CD 113

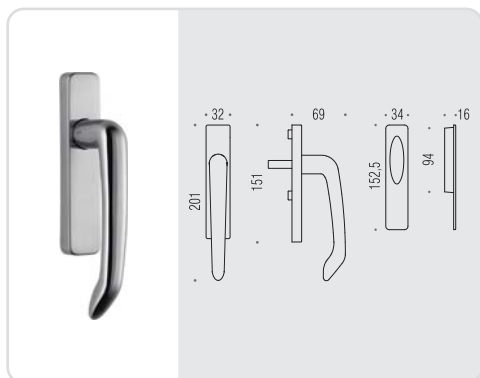

cd213 rs

Design: Colombo Design

MANIGLIONI PER COMPLANARE
PULL FOR COPLANAR SLIDING DOOR

Materiale: Ottone
Material: Brass



CD 213 RS



flessum & toc-toc

Design: Bartoli Design

Design: Alberto Meda

BATTENTI
DOOR KNOCKERS

Materiale: Ottone
Material: Brass



HPS
Zirconium
gold HPS



CM
Cromat
Matt chrome

CB 115 (FLESSUM)

HPS CM

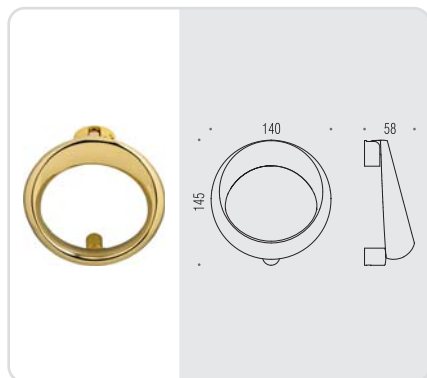

AM 115 (TOC-TOC)

HPS CM

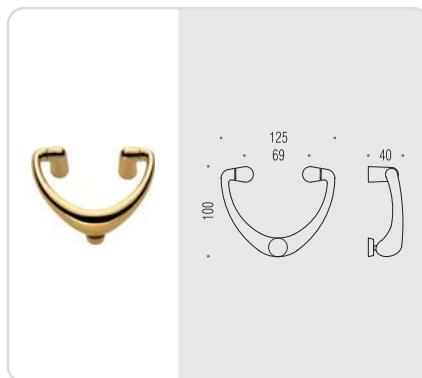

predaj a technická podpora: AROSE s.r.o. / RAČIANSKA 97 / BRATISLAVA / 831 02 / TEL: +421 911 555 454 / E-MAIL: arose@arose.sk

MANIGLIE AD INCASSO FLUSH HANDLES

predaj a technická podpora: AROSE s.r.o. / RAČIANSKA 97 / BRATISLAVA / 831 02 / TEL: +421 911 555 454 / E-MAIL: arose@arose.sk

enter

Design: Luca Colombo

SPESSORE PORTA da 40 a 52mm
DOOR THICKNESS from 40 to 52mm

Materiale: Ottone
Material: Brass



OL
Oroplus



CR
Cromo
Chrome



CM
Cromat
Matt chrome

LC 211

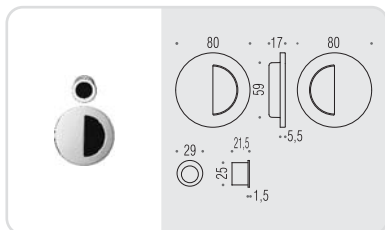

Kit per porta scorrevole composto da due maniglie ad incasso e maniglia di trascimento.
Sliding Doors Kit composed of two groove handles and flush handle.

LC 211 LK

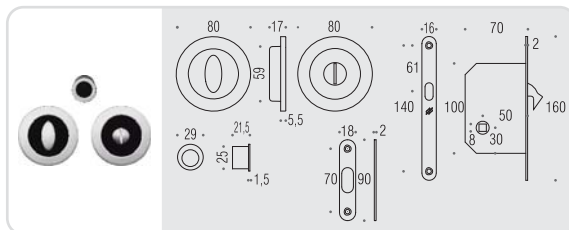

Kit per porta scorrevole composto da due maniglie ad incasso con dispositivo di chiusura a nottolino, maniglia di trascimento e serratura (E 50mm) a gancio dotata di contropietra in acciaio inox.
Sliding Doors Kit composed of two groove handles with thumb turn from one side, flush handle and stainless-steel mortise hook lock (E 50mm) with striking plate.



open

Design: **TEAM 3**

SPESORE PORTA da 40 a 52mm
DOOR THICKNESS from 40 to 52mm

Materiale: Ottone
Material: Brass



ID 211

ID 211 LK

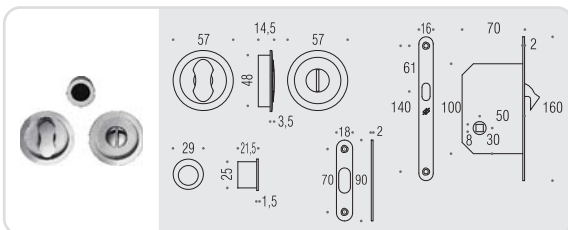
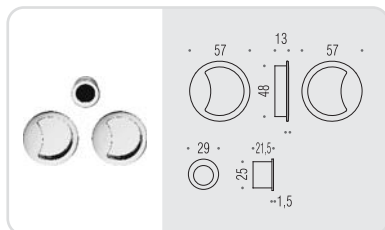

Kit per porta scorrevole composto da due maniglie ad incasso e maniglia di trascinamento.
Sliding Doors Kit composed of two groove handles and flush handle.

Kit per porta scorrevole composto da due maniglie ad incasso con dispositivo di chiusura a nottolino, maniglia di trascinamento e serratura (E 50mm) a gancio dotata di contropiastra in acciaio inox.
Sliding Doors Kit composed of two groove handles with thumb turn from one side, flush handle and stainless-steel mortise hook lock (E 50mm) with striking plate.



open

Design: **TEAM 3**

SPESSORE PORTA da 40 a 52mm
DOOR THICKNESS from 40 to 52mm

Materiale: Ottone
Material: Brass



ID 211 BZG

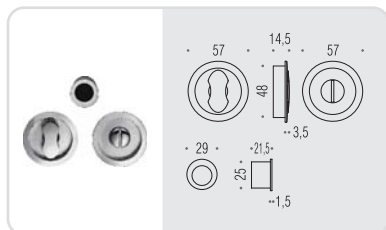

Kit per porta scorrevole composto da due maniglie ad incasso con dispositivo di chiusura a nottolino e maniglietta di trascinamento (senza serratura).

Sliding Doors Kit composed of two groove handles with thumb turn and flush handle (without lock).



Materiale: Ottone
Material: Brass



CR
Cromo
Chrome



CM
Cromat
Matt chrome



GL
Grafite
Graphite



GM
Grafite Mat
Matt graphite



VL
Vintage



VM
Vintage Mat



NM
Neromat
Matt black



BI
Biancomat
Matt white

ID 311

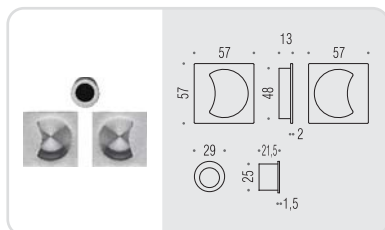

ID 311 LK

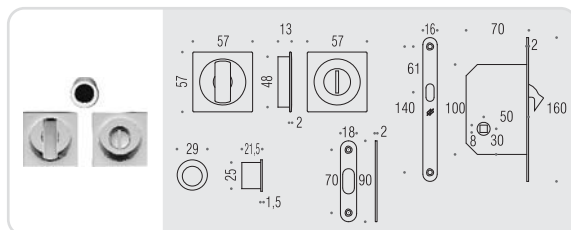

Kit per porta scorrevole composto da due maniglie ad incasso e maniglia di trascinamento.
Sliding Doors Kit composed of two groove handles and flush handle.

Kit per porta scorrevole composto da due maniglie ad incasso con dispositivo di chiusura a nottolino, maniglia di trascinamento e serratura (E 50mm) a gancio dotata di contropiatta in acciaio inox.
Sliding Doors Kit composed of two groove handles with thumb turn from one side, flush handle and stainless-steel mortise hook lock (E 50mm) with striking plate.



Materiale: Ottone
Material: Brass



CR
Cromo
Chrome



CM
Cromat
Matt chrome



GL
Grafito
Graphite



GM
Grafito Mat
Matt graphite



VL
Vintage



VM
Vintage Mat



NM
Neromat
Matt black



BI
Biancomat
Matt white

ID 311 BZG

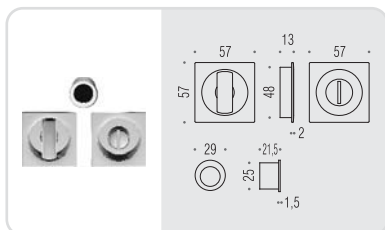

Kit per porta scorrevole composto da due maniglie ad incasso con dispositivo di chiusura a nottolino e maniglietta di trascinamento (senza serratura).

Sliding Doors Kit composed of two groove handles with thumb turn and flush handle (without lock).



cd111 - cd211

Design: Colombo Design

MISURA FRESATA 25 x 90 x 8mm
MILING SIZE 25 x 90 x 8mm

Materiale: Ottone
Material: Brass



OL
Oroplus



OM
Oromat
Matt gold



CR
Cromo
Chrome



CM
Cromat
Matt chrome

BR
Bronzo
Bronze

CD 111

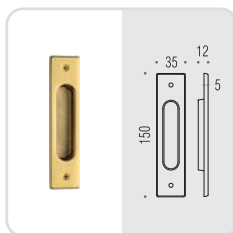

CD 111 CF

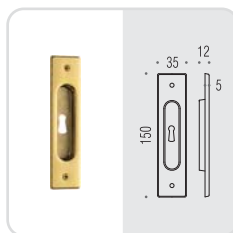

CD 211

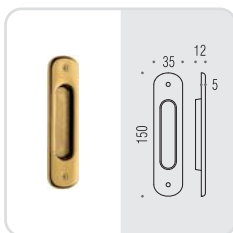

CD 211 CF

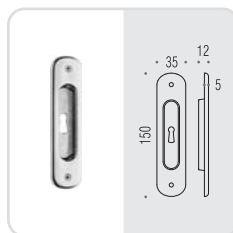

cd311 - cd511

Design: Colombo Design

MISURA FRESATA 28 x 113 x 8mm
MILING SIZE 28 x 113 x 8mm

Materiale: Ottone
Material: Brass



CD 311

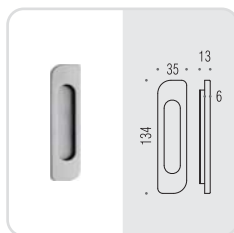

CD 311 CF

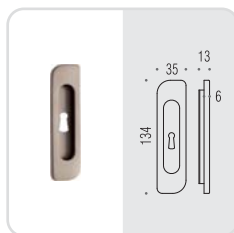

CD 511

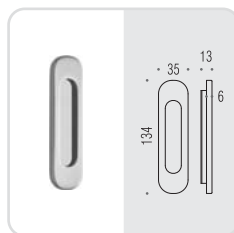

CD 511 CF

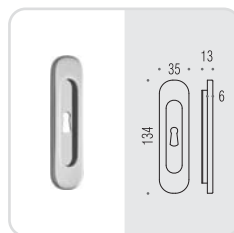

cb111

Design: Carlo Bartoli

MISURA FRESATA 34 x 105 x 10mm
MILING SIZE 34 x 105 x 10mm

Materiale: Cromall®
Material: Cromall®



OL
Cromplus



CM
Cromat
Matt chrome

CB 111

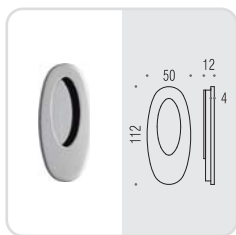

CB 111 CF

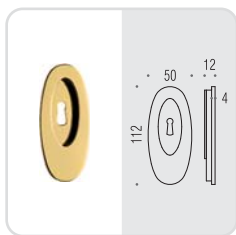

id411

Design: Colombo Design

MISURA FRESATA 28 x 113 x 8mm
MILING SIZE 28 x 113 x 8mm

Materiale: Ottone
Material: Brass



OL
Oroplus



OM
Oromat
Matt gold



CR
Cromo
Chrome



CM
Cromat
Matt chrome



GL
Grafite
Graphite



GM
Grafite Mat
Matt graphite



VL
Vintage



VM
Vintage Mat



NI

Nikelmat
Matt nickel



NM
Neromat
Matt black



BI
Biancomat
Matt white

ID 411



ID 411 CF

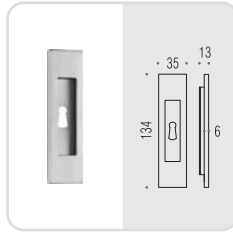
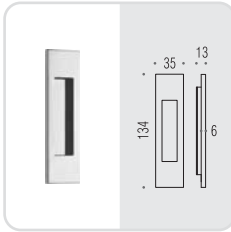

lc111

Design: Luca Colombo

MISURA FRESATA 38 x 98 x 13mm
MILING SIZE 38 x 98 x 13mm

Materiale: Cromall®
Material: Cromall®



OL
Oroplus



CR
Cromo
Chrome



CM
Cromat
Matt chrome

LC 111

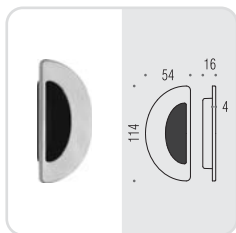

LC 111 CF

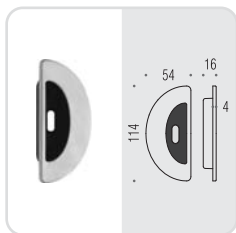

predaj a technická podpora: AROSE s.r.o. / RAČIANSKA 97 / BRATISLAVA / 831 02 / TEL: +421 911 555 454 / E-MAIL: arose@arose.sk

APPENDITUTTO

COAT HANGERS

predaj a technická podpora: AROSE s.r.o. / RAČIANSKA 97 / BRATISLAVA / 831 02 / TEL: +421 911 555 454 / E-MAIL: arose@arose.sk

alizé

Design: Angeletti Ruzza Design

Materiale: Ottone
Material: Brass



CR
Cromo
Chrome

AR 37

CR

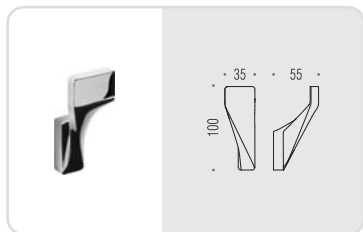

bart

Design: Bartoli Design

Materiale: Ottone
Material: Brass



CR
Cromo
Chrome

CB 67

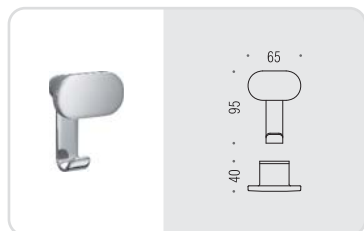

basic

Design: Colombo Design

Materiale: Cromall®
Material: Cromall®



CR
Cromo
Chrome

ID 17

CR

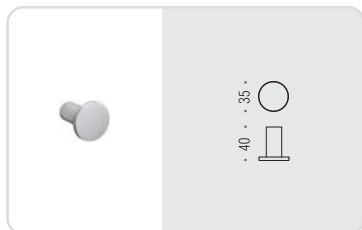

ID 27

CR

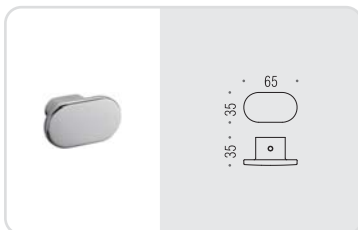

basic Q

Design: Colombo Design

Materiale: Cromall®
Material: Cromall®



CR
Cromo
Chrome

LC 97

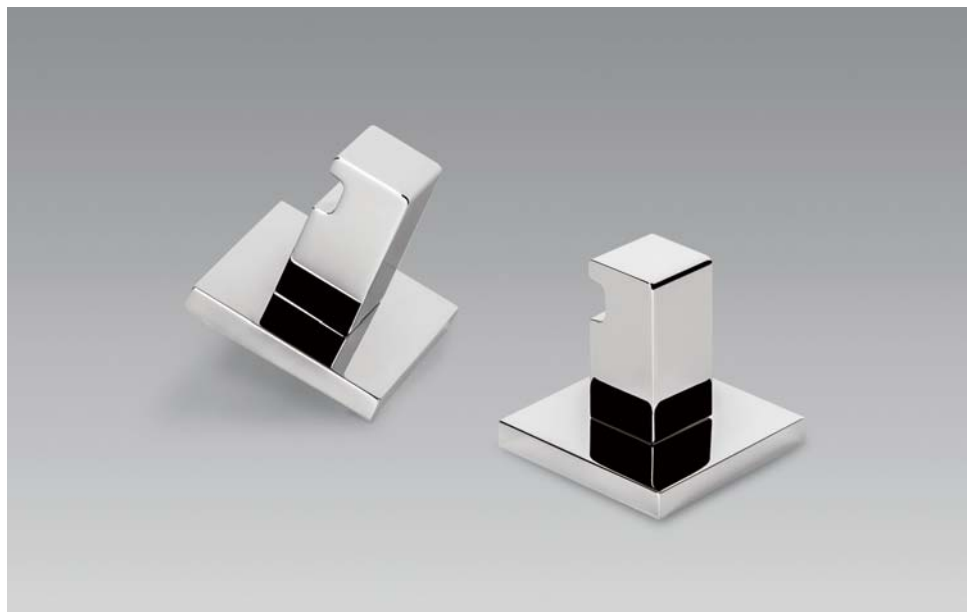
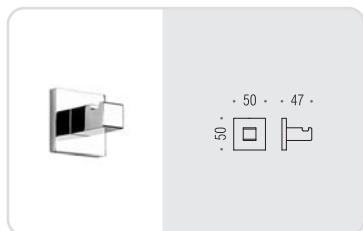

club

Design: Carlo Bartoli

Materiale: Ottone
Material: Brass



CR
Cromo
Chrome

CB 37

CR

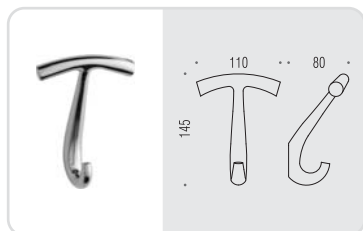

forever

Design: Luca Colombo

Materiale: Ottone
Material: Brass



CR
Cromo
Chrome

LC 67

CR

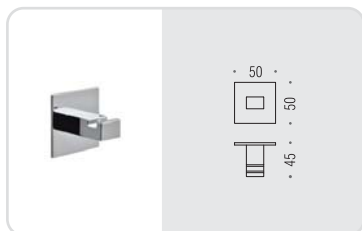

Fissaggio a muro e vetro ottenuto con uno speciale nastro biadesivo in schiuma acrilica ad alte prestazioni (3M™ VHB™).

Attenzione: Si sconsiglia l'applicazione dei pezzi su superfici particolarmente ruvide o poco compatte, così come su intonaci o muri grezzi.

Wall and glass fixing with a special high performance double sided acrylic foam tape (3M™ VHB™).
Attention: we do not recommend the application of the pieces on surfaces particularly rough, as well as on painted walls.



golf

Design: Angeletti Ruzza Design

Materiale: Ottone
Material: Brass



OL
Oroplus

NI
Nikelmat
Matt nickel

AR 17

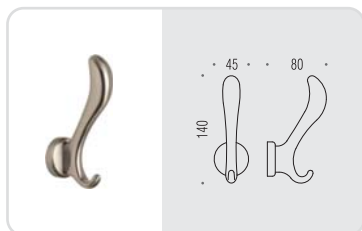

hermitage

Classic Line

Materiale: Ottone
Material: Brass



HPS
Zirconium
gold HPS



CR
Cromo
Chrome

OA
Ottone antico
Antique brass

LC 77

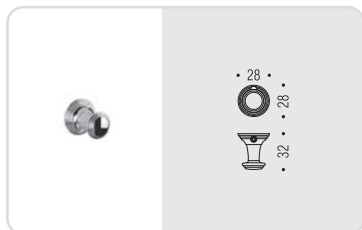

LC 87



hook

Design: Alberto Meda

Materiale: Ottone
Material: Brass



CR
Cromo
Chrome

AM 17 (HOOK 1)

CR

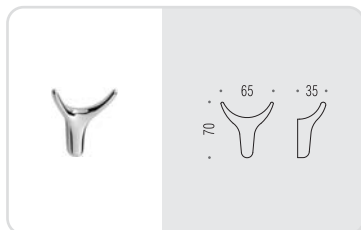

AM 27 (HOOK 2)

CR

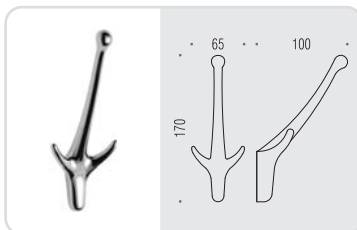

khala

Design: Makio Hasuike

Materiale: Ottone
Material: Brass



MH 17

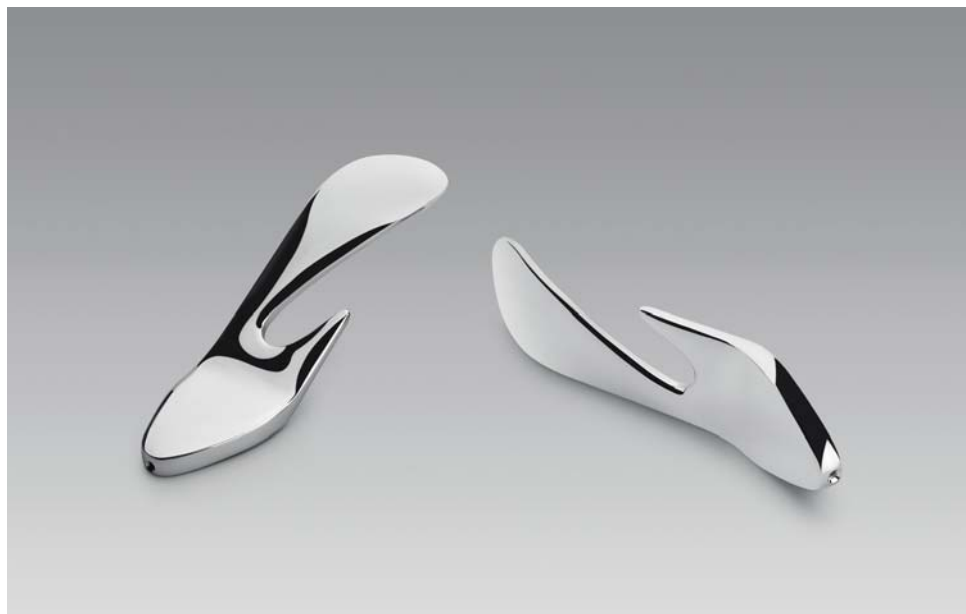
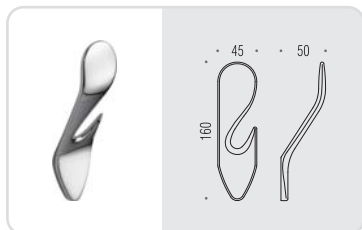

land

Design: **TEAM 3**

Materiale: Ottone
Material: Brass



CR
Cromo
Chrome

CD 67

CR



CD 77

CR



link

Design: Angeletti Ruzza Design

Materiale: Ottone
Material: Brass



AR 27



look

Design: Luca Colombo

Materiale: Cromall®
Material: Cromall®



CR
Cromo
Chrome

LC 27

CR

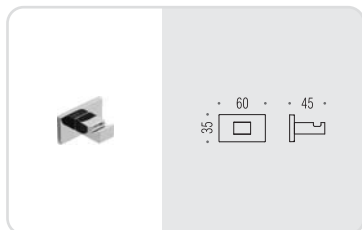

LC 37

CR

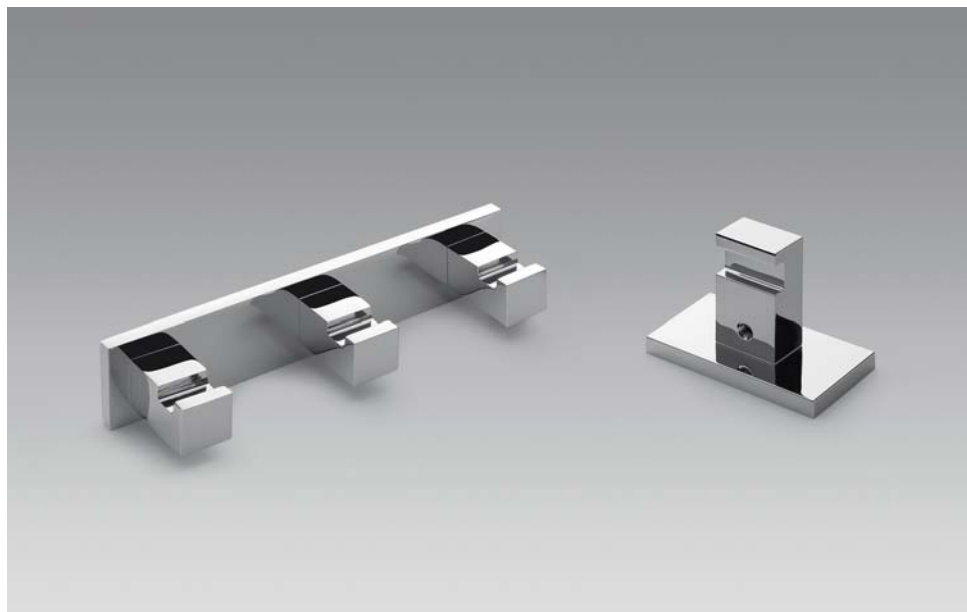
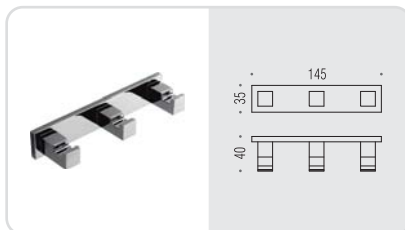

lulù

Design: Luca Colombo

Materiale: Ottone
Material: Brass



HPS
Zirconium
gold HPS



CR
Cromo
Chrome

LC 47



LC 57

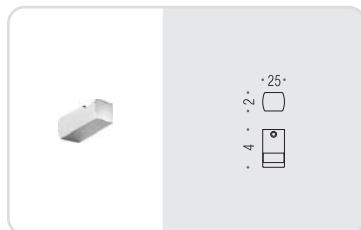

melò

Design: Ambrogio Rossari

Materiale: Cromall®
Material: Cromall®



CR
Cromo
Chrome

RA 17

CR

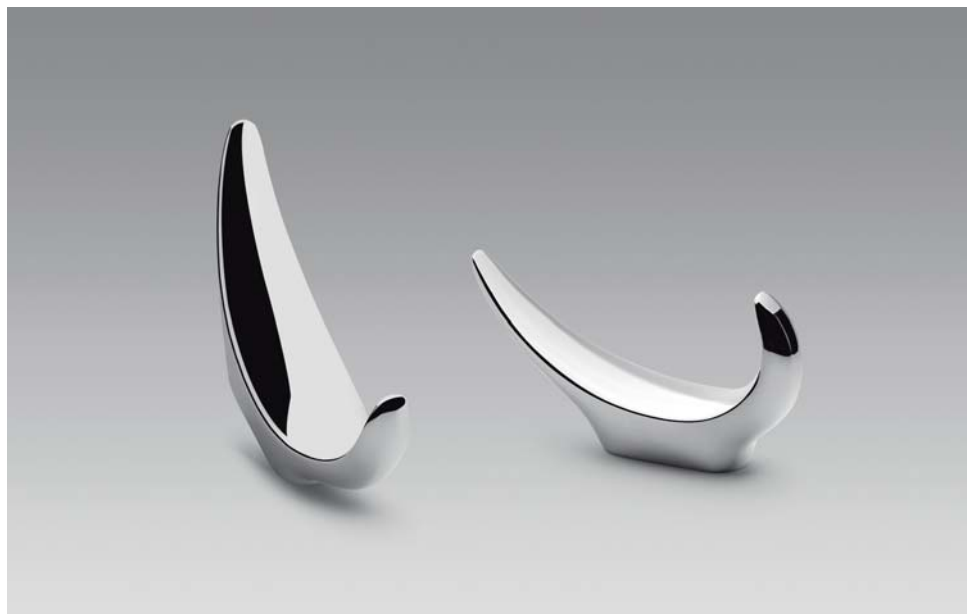
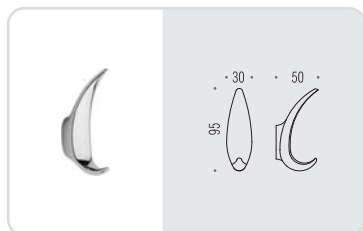

nordic

Design: Efreem Bonacina e Giovanni Moro

Materiale: Cromall®
Material: Cromall®



CR
Cromo
Chrome

EB 17

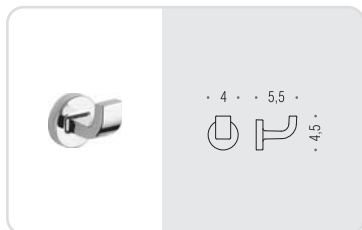

EB 27

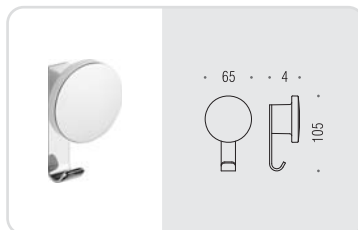

over

Design: Efrem Bonacina e Giovanni Moro

Materiale: Acciaio Inox AISI 316 L
Material: AISI 316 L Inox Stainless Steel



GM 17

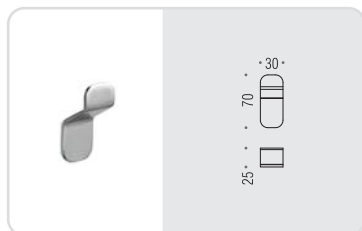

Fissaggio a muro e vetro ottenuto con uno speciale nastro biadesivo in schiuma acrilica ad alte prestazioni (3M™ VHB™).

Attenzione: Si sconsiglia l'applicazione dei pezzi su superfici particolarmente ruvide o poco compatte, così come su intonaci o muri grezzi.

Wall and glass fixing with a special high performance double sided acrylic foam tape (3M™ VHB™).
Attention: we do not recommend the application of the pieces on surfaces particularly rough, as well as on painted walls.

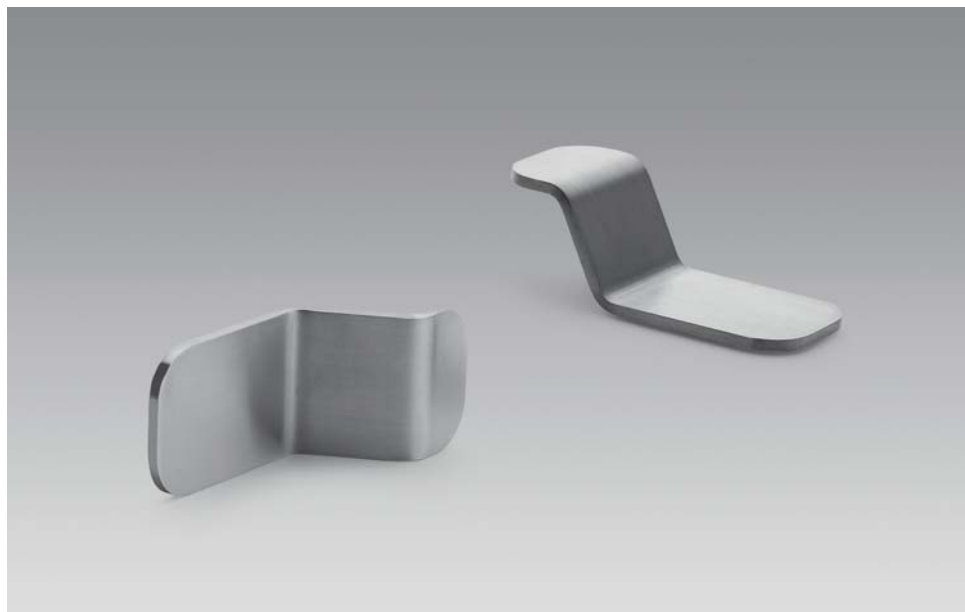

plus

Design: Piet Billekens

Materiale: Ottone
Material: Brass



HPS/1
Zirconium
SS HPS



CR
Cromo
Chrome

PB 17

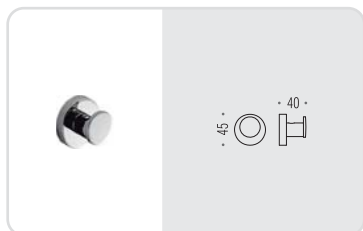

polo

Design: Luca Colombo

Materiale: Cromall®
Material: Cromall®



CR
Cromo
Chrome

LC 17

CR

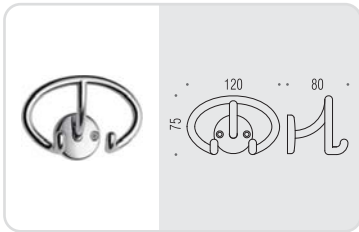

portofino

Design: Classic Line

Materiale: Ottone
Material: Brass



CR
Cromo
Chrome

CD 87

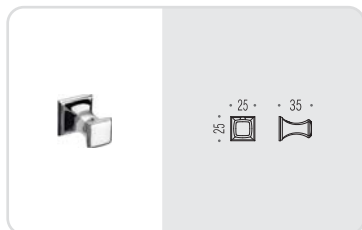

CD 97

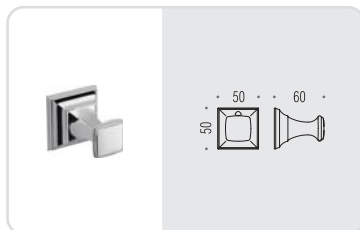

road

Design: **momo**DESIGN

Materiale: Ottone
Material: Brass



CR
Cromo
Chrome

MO 17

CR



time

Design: Colombo Design

Materiale: Ottone
Material: Brass



CD 17

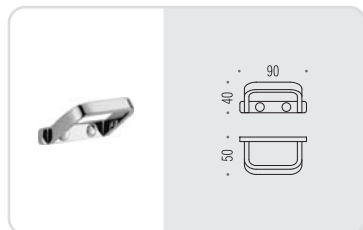

CD 27

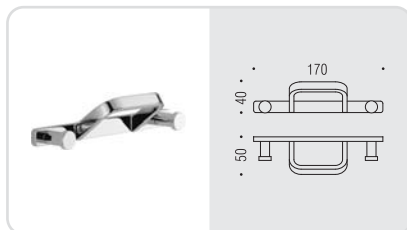

time

Design: Colombo Design

Materiale: Ottone
Material: Brass



CR
Cromo
Chrome

CD 47



CD 37

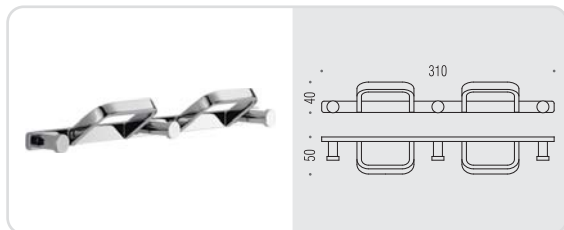

CD 57

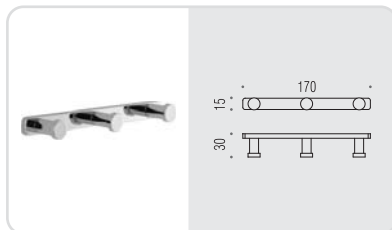

trio

Design: Carlo Bartoli

Materiale: Cromall®/Ottone
Material: Cromall®/Brass



CB 17

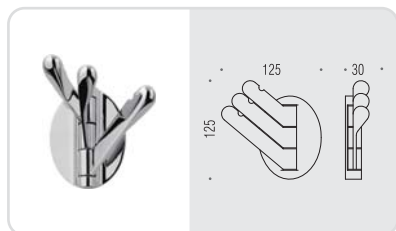

predaj a technická podpora: AROSE s.r.o. / RAČIANSKA 97 / BRATISLAVA / 831 02 / TEL: +421 911 555 454 / E-MAIL: arose@arose.sk

PROGRAMMA
BLINDATE
A R M O R E D
D O O R P R O G R A M

predaj a technická podpora: AROSE s.r.o. / RAČIANSKA 97 / BRATISLAVA / 831 02 / TEL: +421 911 555 454 / E-MAIL: arose@arose.sk

mostrine

ROSE PLATE
Design: Colombo Design

Materiale: Ottone
Material: Brass



NI
Nikelmat
Matt nickel

BR
Bronzo
Bronze



PB 01

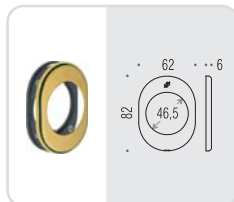

Rosetta con sottorosetta in nylon
compresa di 5 viti di fissaggio
Brass rose supplied with nylon underconstruction
and 5 fixing screws

PB 01 DG

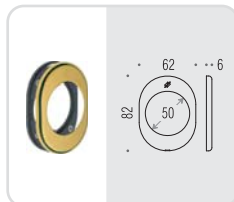

Rosetta con sottorosetta in nylon
per defender ø50mm
compresa di 5 viti di fissaggio
Brass rose supplied with nylon underconstruction
for defender ø50mm and 5 fixing screws

PB 02

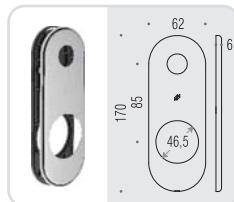

Placca interasse 85mm con sottoplacca
in nylon compresa di 5 viti di fissaggio
(utilizzabile solo con inserti PB06 e PB07)
Brass plate 85 mm distance, supplied with nylon
underconstruction and 5 fixing screws (use only
with underconstruction PB06 and PB07)

PB 02 Y

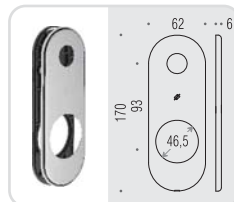

Placca interasse 93mm con sottoplacca
in nylon compresa di 5 viti di fissaggio
(utilizzabile solo con inserti PB05 e PB08)
Brass plate 93 mm distance, supplied with nylon
underconstruction and 5 fixing screws (use only
with underconstruction PB05 and PB08)



mostrine

ROSE PLATE
Design: Colombo Design

Materiale: Ottone
Material: Brass



CR
Cromo
Chrome



CM
Cromat
Matt chrome



GM
Grafite Mat
Matt graphite

PB 01/Q

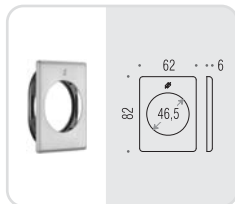

Rosetta quadrata con sottorosetta in nylon compresa di 5 viti di fissaggio.
Square brass rose supplied with nylon underconstruction and 5 fixing screws

PB 01 DG/Q

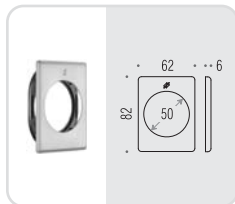

Rosetta quadrata con sottorosetta in nylon per defender ø50mm compresa di 5 viti di fissaggio.
Square brass rose supplied with nylon underconstruction for defender ø50mm and 5 fixing screws.

PB 02/Q

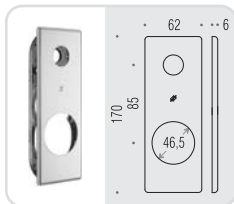

Placca quadrata int. 85mm con sottoplacca in nylon compresa di 5 viti di fissaggio (utilizzabile solo con inserti PB06 e PB07)
Square brass plate 85 mm distance, supplied with nylon underconstruction and 5 fixing screws (use only with underconstruction PB06 and PB07)

PB 02 Y/Q

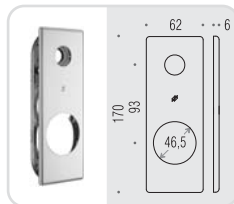

Placca quadrata int. 93mm con sottoplacca in nylon compresa di 5 viti di fissaggio (utilizzabile solo con inserti PB05 e PB08)
Square brass plate 93 mm distance, supplied with nylon underconstruction and 5 fixing screws (use only with underconstruction PB05 and PB08)



inserti per mostrine UNIVERSAL UNDERCONSTRUCTION

Design: Colombo Design

Materiale: Nylon nero
Material: Black nylon

NE
Nero
Black

PB 03 NE



Inserto maniglia
(possibilità montaggio con molla Ø45 mm)
Underconstruction for level handle rose
(Ø45mm spring installation possible)

PB 04 NE

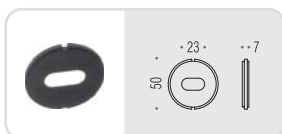

Inserto limitatore d'apertura
Underconstruction for opening limiting device

PB 05 NE

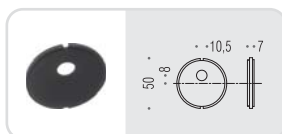

Inserto per cilindro con pomolo
Underconstruction for knob cylinder

PB 06 NE



Inserto doppia mappa universale
compreso di copritoppa
Underconstruction for double ward universal key
with key cover

PB 07 NE



Inserto doppia mappa concavo universale
compreso di copritoppa
Underconstruction for double ward universal key
with key cover

PB 08 NE



Inserto foro yale
Underconstruction for yale key hole



pomolino

Design: Colombo Design

KNOB SET

Materiale: Ottone
Material: Brass



HPS
Zirconium
gold HPS



OL
Oroplus



OM
Oromat
Matt gold



CR
Cromat
Chrome



CM
Cromat
Matt chrome



GM
Grafitte Mat
Matt graphite

NI
Nikelmat
Matt nickel

BR
Bronzo
Bronze



NM
Neromat
Matt black

PB 09

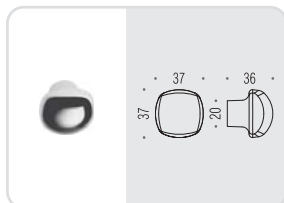

Pomolino Ø35mm per limitatore d'apertura
(e/o per cilindro) cava interna quadro
8mm - Ø9mm
Knob set Ø35mm for opening limiting device
(also for cylinder) spindle 8mm - thread 9mm

PB 09/Q

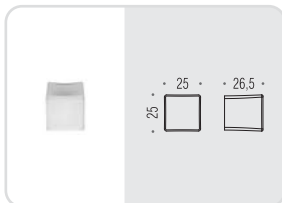

Pomolino quadrato per limitatore d'apertura
(e/o per cilindro) cava interna quadro 8mm
Square knob set for opening limiting device
(also for cylinder) spindle 8mm



kit SR (bocchetta di protezione per cilindro)

Design: Colombo Design

SR KIT (escutcheons cylinder protection)

Materiale: Ottone
Material: Brass



HPS
Zirconium
gold HPS



CR
Cromo
Chrome



CM
Cromat
Matt chrome

BR
Bronzo
Bronze

KIT SR 73 WP

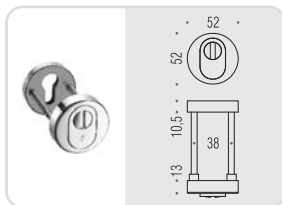

Interasse 38mm
Viti M6x80 TPS+
Centre 38mm
Screws 6MA

KIT SR 93 WP

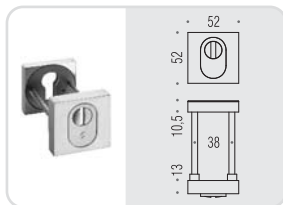

Interasse 38mm
Viti M6x80 TPS+
Centre 38mm
Screws 6MA



COMPLEMENTI COMPLEMENTS

predaj a technická podpora: AROSE s.r.o. / RAČIANSKA 97 / BRATISLAVA / 831 02 / TEL: +421 911 555 454 / E-MAIL: arose@arose.sk

dispositivi di sicurezza

SECURITY WINDOWS SETS

Materiale: Cromall®
Material: Cromall®



OL
Oropius



CR
Cromo
Chrome



CM
Cromat
Matt chrome

CD 42 DK Z Design: Colombo Design



DREH-KIPP Robot con dispositivo a pulsante di sicurezza, con movimento DK (DK Q8 L) incluso. Quadro 7x40.

Carico di rottura **40 N·m**

Button-locked security DK window handle set, DK mechanism included (DK Q8 L). Spindle 7x40. Breaking load **40 N·m**

CD 92 DK Z Design: Colombo Design



DREH-KIPP Robotre con dispositivo a pulsante di sicurezza, con movimento DK (DK Q8 L) incluso. Quadro 7x40.

Carico di rottura **40 N·m**

Button-locked security DK window handle set, DK mechanism included (DK Q8 L). Spindle 7x40. Breaking load **40 N·m**

ID 42 DK Z Design: Colombo Design



DREH-KIPP Roboquattro con dispositivo a pulsante di sicurezza, con movimento DK (DK Q8 L) incluso. Quadro 7x40.

Carico di rottura **40 N·m**

Button-locked security DK window handle set, DK mechanism included (DK Q8 L). Spindle 7x40. Breaking load **40 N·m**



premere pulsante
press button



rotazione 90°
apertura finestra
spin 90° to open
window



premere pulsante
press button



rotazione 90°
anta ribalta
spin 90° for vertical
partial opening



dispositivi di sicurezza

SECURITY WINDOWS SETS

Materiale: Cromall®
Material: Cromall®



OL
Oropius



CR
Cromo
Chrome



CM
Cromat
Matt chrome

ID 52 DK Z Design: Colombo Design



DREH-KIPP Robot con dispositivo a pulsante di sicurezza, con movimento DK (DK Q8 L) incluso. Quadro 7x40.

Carico di rottura **40 N·m**

Button-locked security DK window handle set.

DK mechanism included (DK Q8 L).

Spindle 7x40. Breaking load **40 N·m**

ID 62 DK Z Design: Colombo Design

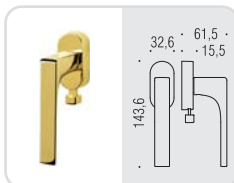

DREH-KIPP Robotre con dispositivo a pulsante di sicurezza, con movimento DK (DK Q8 L) incluso. Quadro 7x40.

Carico di rottura **40 N·m**

Button-locked security DK window handle set.

DK mechanism included (DK Q8 L).

Spindle 7x40. Breaking load **40 N·m**

ID 72 DK Z Design: Colombo Design

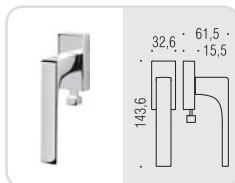

DREH-KIPP Roboquattro con dispositivo a pulsante di sicurezza, con movimento DK (DK Q8 L) incluso. Quadro 7x40.

Carico di rottura **40 N·m**

Button-locked security DK window handle set.

DK mechanism included (DK Q8 L).

Spindle 7x40. Breaking load **40 N·m**



premere
pulsante
press button



rotazione 90°
apertura finestra
spin 90° to open
window



premere
pulsante
press button



rotazione 90°
anta ribalta
spin 90° for vertical
partial opening



dispositivi di sicurezza

SECURITY WINDOWS SETS

Materiale: Ottone/Cromall®/Acciaio (DK Z) - Cromall®/Acciaio (DK Z Q)
 Material: Brass/Cromall®/Steel (DK Z) - Cromall®/Steel (DK Z Q)



HPS
Zirconium
gold HPS



OL
Oroplus



OM
Oromat
Matt gold



HPS/1
Zirconium
stainless-steel HPS



CR
Cromo
Chrome



CM
Cromat
Matt chrome

NI
Nikelmat
Matt nickel

BR
Bronzo
Bronze

CD 02 DK Z Design: Colombo Design

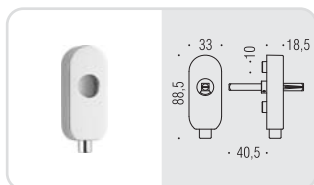

Dispositivo a pulsante di sicurezza, adatto a tutti i modelli di maniglie con movimento DK (DK Q8 L) incluso. Quadro 7x40.

Carico di rottura **60 N·m**

Button-locked security DK window handle set suitable for all handles, DK mechanism included (DK Q8 L), Spindle 7x40. Breaking load **60 N·m**

CD 02 DK Z/Q Design: Colombo Design

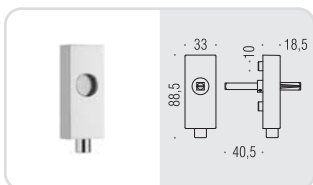

Dispositivo a pulsante di sicurezza quadrato, adatto a tutti i modelli di maniglie con movimento DK (DK Q8 L) incluso. Quadro 7x40.

Carico di rottura **60 N·m**

Button-locked security DK window handle set suitable for all handles, DK mechanism included (DK Q8 L), Spindle 7x40. Breaking load **60 N·m**



premere
pulsante
press button



rotazione 90°
apertura finestra
spin 90° to open
window



premere
pulsante
press button



rotazione 90°
anta ribalta
spin 90° for vertical
partial opening



dispositivi antieffrazione

SECURITY WINDOWS SETS

Materiale: Ottone/Acciaio
Material: Brass/Steel



HPS
Zirconium
gold HPS



OL
Oroplus



CR
Cromo
Chrome



CM
Cromat
Matt chrome

CD 02 DK LOCK Design: Colombo Design

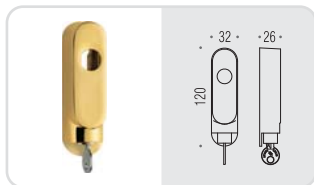

UNI ENV 1627:2011

Dispositivo con sistema di bloccaggio a chiave (cilindro KA stessa cifratura) per antieffrazione, adatto a tutti i modelli di maniglie con movimento DK (DK 40 D) incluso. Quadro 7x40, Carico di rottura **100 N·m**

Key-locked security DK window handle set (KA cylinder same key code) suitable for all handles, DK mechanism included (DK 40 D), Spindle 7x40, Breaking load **100 N·m**



premere chiave
per bloccare
serratura
press key to block
lock



maniglia
sbloccata
unblocked
handle



ruotare chiave
per sbloccare
serratura
rotate key in order
to unblock lock



rotazione 90°
apertura finestra
spin 90° to open
window



premere chiave
per bloccare
serratura
press key to block
lock



fermaporta DOOR STOPPERS

Materiale: Ottone (CD 112, CD 312, CD 412) - Cromall® (LC 112)
 Material: Brass (CD 112, CD 312, CD 412) - Cromall® (LC 112)



CD 112 Design: Colombo Design



Il gommino è sempre di colore nero
 Black rubber ring

CD 312 Design: Colombo Design

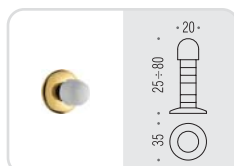

Regolabile in altezza da 25 a 80mm.
 Il gommino superiore è sempre di colore bianco.
 Adjustable from 25 to 80mm, White rubber ring.

CD 412 Design: Colombo Design

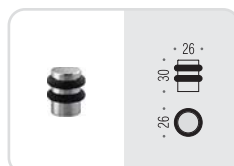

Il gommino è sempre di colore nero
 Black rubber ring

LC 112 Design: Luca Colombo

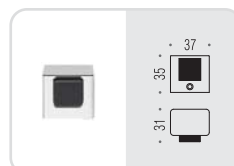

La gomma è di colore nero
 Black rubber.

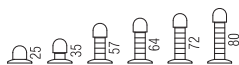

chiavi KEYS

Materiale: Ottone
Material: Brass



OL
Oroplius



OM
Oromat
Matt gold



CR
Cromo
Chrome



CM
Cromat
Matt chrome

NI
Nikelmat
Matt nickel

BR
Bronzo
Bronze

BA
Bronzo antico
Antique bronze

OA
Ottone antico
Antique brass



NM
Neromat
Matt black

AM 14 Design: Alberto Meda

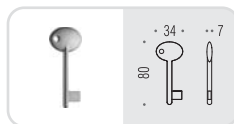

AR 14 Design: Angeletti Ruzza Design

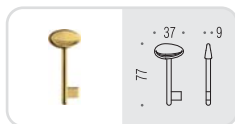

CB 24 Design: Carlo Bartoli



CD 14 Design: Colombo Design

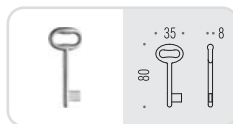

LC 14 Design: Luca Colombo

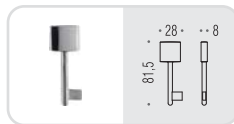

LC 24 Design: Luca Colombo

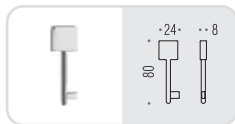

nottolini

TOILET ROSES

Materiale: Ottone/Cromall®
Material: Brass/Cromall®



HPS
Zirconium
gold HPS



OL
Oroplus



OM
Oromat
Matt gold



HPS/1
Zirconium
SS HPS



CR
Cromo
Chrome



CM
Cromat
Matt chrome



VL
Vintage



VM
Vintage Mat



NI
Nikelmat
Matt nickel



BR
Bronzo
Bronze



BA
Bronzo antico
Antique bronze



OA
Ottone antico
Antique brass



NM
Neromat
Matt black



BI
Biancomat
Matt white

BT 19 BZG 6/8

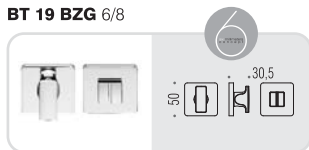

OL CR CM VL VM

CD 39 BZG 6/8

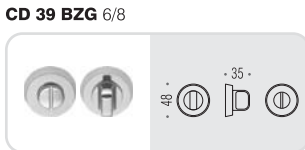

CR CM

CD 49 BZG G 6/8



OL OM HPS1 CR CM NI BI

CD 69 BZG 6/8



HPS OL OM CR CM NI BR NM BI

CD 69 BZG G 6/8



OL CR CM NI BR BA OA

CD 79 BZG 6/8



OL BR



nottolini TOILET ROSES

Materiale: Ottone/Cromal®
Material: Brass/Cromal®



FF 29 BZG 6/8

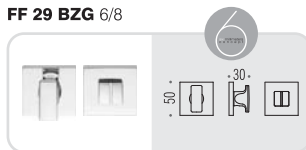

MF 19 BZG 6/8

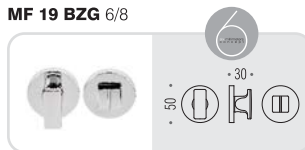

MR 29 BZG G 6/8



PT 19 BZG 6/8

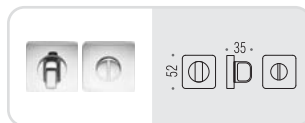

DB 19 BZG 6/8



FF 19 BZG 6/8



MM 29 BZG 6/8

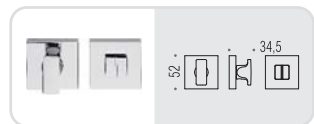

SE 19 BZG 6/8



libero/occupato

TOILET ROSES WITH PRIVACY INDICATOR

Materiale: Ottone/Cromall®
Material: Brass/Cromall®



OL
Oropius



CR
Cromo
Chrome



CM
Cromat
Matt chrome



GL
Grafite
Graphite



GM
Grafite Mat
Matt graphite

CD 49 BZG H 6



OL CR CM

CD 69 BZG H 6



OL CR CM

MM 19 BZG H 6

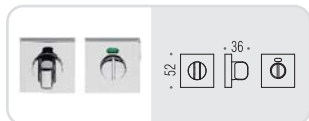

CR CM

MR 19 BZG G 6/8



CR CM

PT 19 BZG H 6



CR CM

SE 19 BZG H 6/8



CR CM GL GM



bocchette tonde ROUND ESCUTCHEONS

Materiale: Ottone/Cromall®
Material: Brass/Cromall®

 HPS Zirconium gold HPS	 OL Oroplus	 OM Oromat Matt gold	 HPS/1 Zirconium SS HPS	 CR Cromo Chrome	 CM Cromat Matt chrome		
 GL Grafite Graphite	 GM Grafite Mat Matt graphite	NI Nikelmat Matt nickel	BR Bronzo Bronze	BA Bronzo antico Antique bronze	OA Ottone antico Antique brass	 NM Neromat Matt black	 BI Biancomat Matt white

CD 33

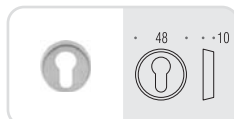

HPS CM NI

CD 43 G B

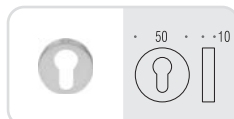

HPS OL OM HPS1 CR CM
NI NM BI

CD 63



HPS OL OM HPS1 CR CM
NI BR BA NM BI

CD 63 G B

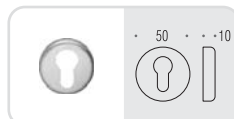

HPS OL OM HPS1 CR CM
NI BR BA OA

CD 1003

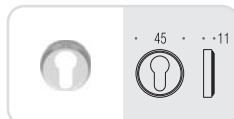

OL BR

DB 13

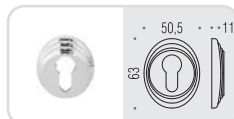

OL CR BR

FF 13

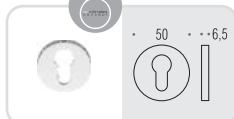

CR CM GL GM



bocchette quadre SQUARE ESCUTCHEONS

Materiale: Ottone/Cromall®
Material: Brass/Cromall®



HPS
Zirconium
gold HPS



OL
Oroplus



CR
Cromo
Chrome



CM
Cromat
Matt chrome



GL
Grafite
Graphite



GM
Grafite Mat
Matt graphite



VL
Vintage



VM
Vintage Mat



NM
Neromat
Matt black



BI
Biancomat
Matt white

BT 13

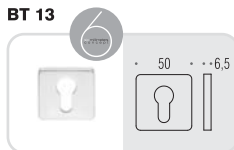

HPS OL CR CM VL VM

FF 23

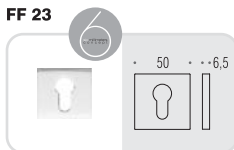

CR CM VL VM

MM 13

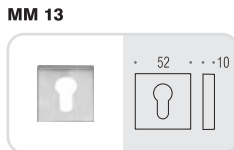

CR CM GL GM NM BI

PT 13

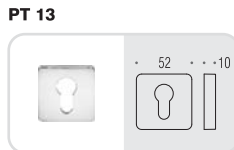

OL CR CM VL VM

MR 13



CR CM



rosette strette

OVAL ROSE

Materiale: Ottone
Material: Brass

Adattabili a tutti i modelli di maniglie
Suitable for all types of door handles



HPS
Zirconium
gold HPS



OL
Oroplus



OM
Oromat
Matt gold



HPS/1
Zirconium
SS HPS



CR
Cromo
Chrome



CM
Cromat
Matt chrome



VL
Vintage



VM
Vintage Mat



NI
Nikelmat
Matt nickel



BR
Bronzo
Bronze



BA
Bronzo antico
Antique bronze



OA
Ottone antico
Antique brass



GL
Grafite
Graphite



GM
Grafite Mat
Matt graphite



NM
Neromat
Matt black



BI
Biancomat
Matt white

CD 73 RS/M

Rosetta stretta con molla
Oval escutcheon spring loaded

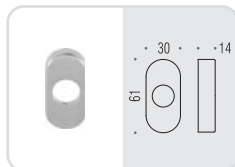

CD 73 RS

Rosetta stretta senza molla
Oval escutcheon without spring

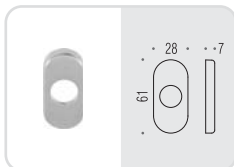

MM 13 RS

Rosetta stretta quadra senza molla
Square escutcheon without spring

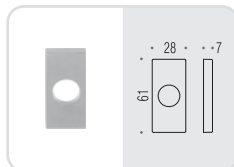

MM 13 RS/M

Rosetta stretta quadra con molla
Square escutcheon spring loaded

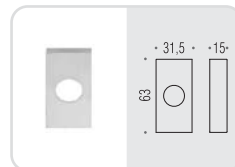

bocchette strette

OVAL ESCUTCHEONS

Materiale: Ottone
Material: Brass

Adattabili a tutti i modelli di maniglie
Suitable for all types of door handles



HPS
Zirconium
gold HPS



OL
Oroplus



OM
Oromat
Matt gold



HPS/1
Zirconium
SS HPS



CR
Cromo
Chrome



CM
Cromat
Matt chrome



VL
Vintage



VM
Vintage Mat



NI
Nikelmat
Matt nickel



BR
Bronzo
Bronze



BA
Bronzo antico
Antique bronze



OA
Ottone antico
Antique brass



GL
Grafite
Graphite



GM
Grafite Mat
Matt graphite



NM
Neromat
Matt black



BI
Biancomat
Matt white

CD 73 BS

Bocchetta stretta yale
Oval escutcheon spring loaded

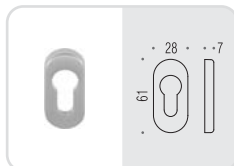

CD 73 BS BB

Bocchetta stretta patent
Oval escutcheon without spring

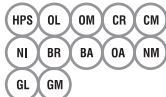
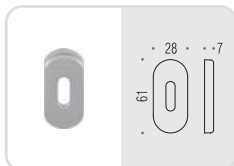

MM 13 BS

Bocchetta stretta quadra yale
Square escutcheon without spring

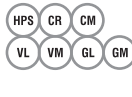
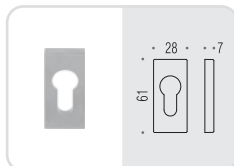





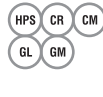
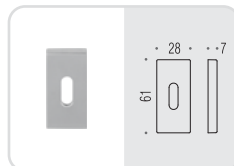







































MM 13 BS BB

Bocchetta stretta quadra patent
Square escutcheon spring loaded



glossario GLOSSARY

	ITALIANO	ENGLISH	FRANÇAIS	DEUTSCHE	ESPAÑOL
MATERIALE MATERIAL	Cromall®	Cromall® alloy	Alliage Cromall®	Cromall® Legierung	Aleación Cromall®
	Ottone	Brass	Laiton	Messing	Latón
	Tecnopolimero	Technopolymer	Technopolymer	Technopolymer	Technopolymer

	ITALIANO	ENGLISH	FRANÇAIS	DEUTSCHE	ESPAÑOL
COLORI BASE MAIN COLORS	Biancomat	Matt white	Blanche mate	Weiss matt	Blanco-mate
	Bronzo	Bronze	Bronze	Bronziert	Bronce
	Bronzo Antico	Antique Bronze	Bronze ancien	Bronze Antik	Bronce antiguo
	 Cromat	 Matt chrome	 Chromé mate	 Chrom matt	 Cromado-mate
	 Cromo	 Chrome	 Chromé	 Chrom	 Cromado
	Neromat	Matt black	Noire mate	Schwarz matt	Negro-mate
	Nichelmat	Matt nickel	Nikel-mat	Matt-Nickel	Nequel mate
	 Oroplus	 Oroplus	 Oroplus	 Oroplus	 Oroplus
	Oromat	Matt gold	Or-mat	Matt-Vergoldet	Laton mate
	Ottone antico	Antique brass	Laiton ancien	Altmessing	Laton antiguo
	 Stainless-Steel	 Stainless-Steel	 Stainless-Steel	 Stainless-Steel	 Stainless-Steel
	 Zirconium Gold	 Zirconium Gold	 Zirconium Gold	 Zirconium Gold	 Zirconium Gold
	 Vintage	 Vintage	 Vintage	 Vintage	 Vintage
	 Vintage Mat	 Vintage Mat	 Vintage Mat	 Vintage Mat	 Vintage Mate
	 Grafite	 Graphite	 Graphite	 Graphit	 Grafito
	 Grafite Mat	 Matt Graphite	 Graphite Mat	 Graphit Matt	 Grafito Mate

	ITALIANO	ENGLISH	FRANÇAIS	DEUTSCHE	ESPAÑOL
COLORI LEGNO WOOD COLORS	Carbonium	Carbonium	Carbonium	Carbonium	Carbonium
	Ebano Makassar	Makassar Ebony	Ébène Makassar	Makassar Ebenholz	Ebano Makassar
	Pero	Pear wood	Poirier	Birnbaumholz	Pera

glossario GLOSSARY

	ITALIANO	ENGLISH	FRANÇAIS	DEUTSCHE	ESPAÑOL
FAMIGLIE MERCEOLOGICHE PRODUCT RANGE	Maniglie	Door-handles	Béquilles	Türdrücker	Manillas
	Pomoli	Door-knobs	Boutons	Türkнопfe	Pomos
	Maniglioni	Pulls	Poignées	Türgriffe	Tiradores
	Maniglioni senza rosette	Pulls without roses	Poignées sans rosette	Griffe ohne Rosetten	Tirador sin roseta
	Maniglioni con rosette	Pulls with roses	Poignées avec rosette	Griffe auf Rosetten	Tirador con roseta
	Maniglioni per alzante scorrevole	Lifted sliding door pulls	Poignées pour porte coulissante qui se souleve	Hebe-Schiebetürgriffe	Tirador para puertas deslizantes
	Maniglione per coplanare	Pull for coplanar sliding doors	Poignée pour porte coulissante coplanaire	Schiebetürgriffe	Tirador para puertas deslizantes
	Battiporta	Door-knocker	Butée	Türklopfer	Picaporte
	Maniglie incasso	Groove handles	Poignée à rainure	Muschelgriffe	Tirador de ranura
	Appenditutto	Coat-hangers	Patères	Hacken	Perchas
	Programma blindate	Door armored progr.	Porte blindées	Sichereitsbeschläge	Programma blindaje
	Mostrine	Rose plates	Rosace / Plaques	Rosetten	Roseta
	Inseriti per mostrine	Universal undercontruction	Sous construction Universel	Unterkonstruktionen	Roseta de empotrar
	Pomolino	Knob set	Set de poignées	Kleinknopf	Pomo
	Complementi	Complements	Compléments	Zubehör	Complementos
	Dispositivi antieffrazione	Sets against window breacking	Set de protection anti bris de glace	Sicherheitssätze	Dispositivo antivándalico
	Fermaporta	Door stopper	Butées	Türpuffer	Topes de puerta
	Chiavi	Keys	Clés	Schlüssel	Llaves
	Bocchette	Escutcheons	Couvre serrure	Schlüsselrosetten	Bocallave
	Bocchette strette	Oval escutcheons	Couvre serrure oval	Oval-Schlüsselrosetten	Cerradura ovalada
Rosette	Roses	Rosettes	Drückerrosetten	Rosetas	
Rosette strette	Oval roses	Rosettes ovales	Oval-Drückerrosetten	Rosetas ovaladas	

predaj a technická podpora:

AROSE s.r.o.
showroom dverí a kľučiek
RAČIANSKA 97, BRATISLAVA, 831 02
TEL: +421 911 555 454
E-MAIL: arose@arose.sk



COLOMBO DESIGN S.p.A.
Via Baccanello, 22
24030 Terno d'Isola (BG) Italia
☎ 035.49.49.001
Fax 035.90.54.44

Export Office
☎ (+39) 035.90.54.75
Fax (+39) 035.49.40.257

Internet: <http://www.colombodesign.it>
e-mail: info@colombodesign.it

follow us on



0 1 1 9 1 0 0 7 2 3